



user's manual
nxs/p frequency converters
enclosures ip21 and ip54

AT LEAST THE 10 FOLLOWING STEPS OF THE *START-UP QUICK GUIDE* MUST BE PERFORMED DURING THE INSTALLATION AND COMMISSIONING.

IF ANY PROBLEMS OCCUR, PLEASE CONTACT YOUR LOCAL DISTRIBUTOR.

Start-up Quick Guide

1. Check that the delivery corresponds to your order, see Chapter 1.
2. Before taking any commissioning actions read carefully the safety instructions in Chapter 1.
3. Before the mechanical installation, check the minimum clearances around the unit and check the ambient conditions in Chapter 5.
4. Check the size of the motor cable, mains cable, mains fuses and check the cable connections, read Chapters 6.1.1.1 to 6.1.1.5.
5. Follow the installation instructions, see Chapter 6.1.5.
6. Control connections are explained in Chapter 6.2.1.
7. If the Start-Up wizard is active, select the language of the keypad and the application you want to use and confirm by pressing the *Enter button*. If the Start-Up wizard is not active, follow the instructions 7a and 7b.
 - 7a. Select the language of the keypad from the Menu **M6**, page **6.1**. Instructions on using the keypad are given in Chapter 7.
 - 7b. Select the application you want to use from the Menu **M6**, page **6.2**. Instructions on using the keypad are given in Chapter 7.
8. All parameters have factory default values. In order to ensure proper operation, check the rating plate data for the values below and the corresponding parameters of parameter group G2.1.
 - nominal voltage of the motor
 - nominal frequency of the motor
 - nominal speed of the motor
 - nominal current of the motor
 - motor $\cos\phi$All parameters are explained in the All in One Application Manual.
9. Follow the commissioning instructions, see Chapter 8.
10. The Vacon NX_ Frequency Converter is now ready for use.

Vacon Plc is not responsible for the use of the frequency converters against the instructions.

CONTENTS

VACON NXS/P USER'S MANUAL

INDEX

- 1 SAFETY
- 2 EU DIRECTIVE
- 3 RECEIPT OF DELIVERY
- 4 TECHNICAL DATA
- 5 INSTALLATION
- 6 CABLING AND CONNECTIONS
- 7 CONTROL KEYPAD
- 8 COMMISSIONING
- 9 FAULT TRACING

ABOUT THE VACON NXS/P USER'S MANUAL

Congratulations for choosing the Smooth Control provided by Vacon NX Frequency Converters!

The User's Manual will provide you with the necessary information about the installation, commissioning and operation of Vacon NX Frequency Converters. We recommend that you carefully study these instructions before powering up the frequency converter for the first time.

This manual is available in both paper and electronic editions. We recommend you to use the electronic version if possible. If you have the **electronic version** at your disposal you will be able to benefit from the following features:

The manual contains several links and cross-references to other locations in the manual which makes it easier for the reader to move around in the manual, to check and find things faster.

The manual also contains hyperlinks to web pages. To visit these web pages through the links you must have an internet browser installed on your computer.

All specifications and information are subject to changes without further notice

Vacon NXS/P User's Manual

Index

Document code: ud00701T

Date: 21.6.2007

1.	SAFETY	7
1.1	Warnings	7
1.2	Safety instructions	7
1.3	Earthing and earth fault protection	8
1.4	Running the motor.....	8
2.	EU DIRECTIVE	9
2.1	CE marking	9
2.2	EMC directive	9
2.2.1	General.....	9
2.2.2	Technical criteria.....	9
2.2.3	Vacon frequency converter EMC classification	9
2.2.3.1	Environment definitions in product standard EN 61800-3 (2004).....	10
2.2.4	Manufacturer's declaration of conformity.....	10
3.	RECEIPT OF DELIVERY	14
3.1	Type designation code	14
3.2	Storage	15
3.3	Maintenance.....	15
3.3.1	Capacitor recharge.....	15
3.4	Warranty.....	16
4.	TECHNICAL DATA	17
4.1	Introduction.....	17
4.2	Power ratings.....	19
4.2.1	Vacon NX_5 – Mains voltage 380—500 V.....	19
4.2.2	Vacon NX_6 – Mains voltage 525—690 V.....	20
4.2.3	Vacon NXS2 – Mains voltage 208—240 V	21
4.3	Brake resistor ratings	22
4.4	Technical data.....	24
5.	INSTALLATION	26
5.1	Mounting	26
5.2	Cooling	36
5.2.1	FR4 to FR9.....	36
5.2.2	Standalone units (FR10 to FR12).....	38
5.3	Power losses.....	40
5.3.1	Power losses as function of switching frequency	40
6.	CABLING AND CONNECTIONS	44
6.1	Power unit	44
6.1.1	Power connections	44
6.1.1.1	Mains and motor cables	44
6.1.1.2	DC supply and brake resistor cables.....	45
6.1.1.3	Control cable	45
6.1.1.4	Cable and fuse sizes, NX_2 and NX_5, FR4 to FR9	45
6.1.1.5	Cable and fuse sizes, NX_6, FR6 to FR9	46
6.1.1.6	Cable and fuse sizes, NX_5, FR10 to FR12	47
6.1.1.7	Cable and fuse sizes, NX_6, FR10 to FR12	47
6.1.2	Understanding the power unit topology.....	48

6.1.3	Changing the EMC protection class	49
6.1.4	Mounting of cable accessories	51
6.1.5	Installation instructions	53
6.1.5.1	Stripping lengths of motor and mains cables	54
6.1.5.2	Vacon NX_ frames and installation of cables	55
6.1.6	Cable selection and unit installation in accordance with the UL standards	65
6.1.7	Cable and motor insulation checks	65
6.2	Control unit	66
6.2.1	Control connections	67
6.2.1.1	Control cables	68
6.2.1.2	Galvanic isolation barriers	68
6.2.2	Control terminal signals	69
6.2.2.1	Digital input signal inversions	70
6.2.2.2	Jumper selections on the OPT-A1 basic board	71
7.	CONTROL KEYPAD	73
7.1	Indications on the Keypad display	73
7.1.1	Drive status indications	73
7.1.2	Control place indications	74
7.1.3	Status LEDs (green – green – red)	74
7.1.4	Text lines	74
7.2	Keypad push-buttons	75
7.2.1	Button descriptions	75
7.3	Navigation on the control keypad	76
7.3.1	Monitoring menu (M1)	78
7.3.2	Parameter menu (M2)	79
7.3.3	Keypad control menu (M3)	81
7.3.3.1	Selection of control place	81
7.3.3.2	Keypad reference	82
7.3.3.3	Keypad direction	82
7.3.3.4	Stop button activated	82
7.3.4	Active faults menu (M4)	83
7.3.4.1	Fault types	84
7.3.4.2	Fault codes	85
7.3.4.3	Fault time data record	89
7.3.5	Fault history menu (M5)	90
7.3.6	System menu (M6)	91
7.3.6.1	Language selection	93
7.3.6.2	Application selection	93
7.3.6.3	Copy parameters	94
7.3.6.4	Parameter comparison	96
7.3.6.5	Security	97
7.3.6.6	Keypad settings	99
7.3.6.7	Hardware settings	100
7.3.6.8	System info	102
7.3.7	Expander board menu (M7)	106
7.4	Further keypad functions	106
8.	COMMISSIONING	107
8.1	Safety	107
8.2	Commissioning of the frequency converter	107
9.	FAULT TRACING	110

1. SAFETY



ONLY A COMPETENT ELECTRICIAN MAY CARRY OUT
THE ELECTRICAL INSTALLATION



1.1 Warnings

 WARNING	1	The Vacon NX_ frequency converter is meant for fixed installations only.
	2	Do not perform any measurements when the frequency converter is connected to the mains.
	3	Do not perform any voltage withstand tests on any part of Vacon NX_. There is a certain procedure according to which the tests shall be performed. Ignoring this procedure may result in damaged product.
	4	The earth leakage current of Vacon NX_ frequency converters exceeds 3.5mA AC. According to standard EN61800-5-1, a reinforced protective ground connection must be ensured. See chapter 1.3.
	5	If the frequency converter is used as a part of a machine, the machine manufacturer is responsible for providing the machine with a main switch (EN 60204-1).
	6	Only spare parts delivered by Vacon can be used.
	7	The motor starts at power-up if the start command is 'ON'. Furthermore, the I/O functionalities (including start inputs) may change if parameters, applications or software are changed. Disconnect, therefore, the motor if an unexpected start can cause danger.
	8	Prior to measurements on the motor or the motor cable, disconnect the motor cable from the frequency converter.
	9	Do not touch the components on the circuit boards. Static voltage discharge may damage the components.

1.2 Safety instructions

	1	The components of the power unit of the frequency converter are live when Vacon NX_ is connected to mains potential. Coming into contact with this voltage is extremely dangerous and may cause death or severe injury. The control unit is isolated from mains potential.
	2	The motor terminals U, V, W and the DC-link/brake resistor terminals are live when Vacon NX_ is connected to mains, even if the motor is not running.
	3	After disconnecting the frequency converter from the mains, wait until the fan stops and the indicators on the keypad go out (if no keypad is attached see the indicators on the cover). Wait 5 more minutes before doing any work on Vacon NX_ connections. Do not even open the cover before this time has expired.
	4	The control I/O-terminals are isolated from the mains potential. However, the relay outputs and other I/O-terminals may have a dangerous control voltage present even when Vacon NX_ is disconnected from mains.
	5	Before connecting the frequency converter to mains make sure that the Vacon NX_ front and cable covers are closed.

1.3 Earthing and earth fault protection

The Vacon NX_ frequency converter must always be earthed with an earthing conductor connected to the earthing terminal .

The earth leakage current of Vacon NX_ exceeds 3.5mA AC. According to EN61800-5-1, one or more of the following conditions for the associated protective circuit shall be satisfied:

- The protective conductor shall have a cross-sectional area of at least 10 mm² Cu or 16 mm² Al, through its total run.
- Where the protective conductor has a cross-sectional area of less than 10 mm² Cu or 16 mm² Al, a second protective conductor of at least the same cross-sectional area shall be provided up to a point where the protective conductor has a cross-sectional area not less than 10 mm² Cu or 16 mm² Al.
- Automatic disconnection of the supply in case of loss of continuity of the protective conductor. See chapter 6.

The cross-sectional area of every protective earthing conductor which does not form part of the supply cable or cable enclosure shall, in any case, be not less than:

- 2,5mm² if mechanical protection is provided or
- 4mm² if mechanical protection is not provided.



The earth fault protection inside the frequency converter protects only the converter itself against earth faults in the motor or the motor cable. It is not intended for personal safety.

Due to the high capacitive currents present in the frequency converter, fault current protective switches may not function properly.

1.4 Running the motor

Warning symbols

For your own safety, please pay special attention to the instructions marked with the following symbols:

	= <i>Dangerous voltage</i>
	= <i>General warning</i>
	= <i>Hot surface – Risk of burn</i>

MOTOR RUN CHECK LIST

	1	Before starting the motor, check that the motor is mounted properly and ensure that the machine connected to the motor allows the motor to be started.
	2	Set the maximum motor speed (frequency) according to the motor and the machine connected to it.
	3	Before reversing the motor make sure that this can be done safely.
	4	Make sure that no power correction capacitors are connected to the motor cable.
	5	Make sure that the motor terminals are not connected to mains potential.

2. EU DIRECTIVE

2.1 CE marking

The CE marking on the product guarantees the free movement of the product within the EEA (European Economic Area).

Vacon NX_ frequency converters carry the CE label as a proof of compliance with the Low Voltage Directive (LVD) and the Electro Magnetic Compatibility (EMC). The company [SGS FIMKO](#) has acted as the Competent Body.

2.2 EMC directive

2.2.1 *General*

The EMC Directive provides that the electrical apparatus must not excessively disturb the environment it is used in, and, on the other hand, it shall have an adequate level of immunity toward other disturbances from the same environment.

The compliance of Vacon NX_ frequency converters with the EMC directive is verified with Technical Construction Files (TCF) checked and approved by SGS FIMKO, which is a [Competent Body](#). The Technical Construction Files are used to authenticate the conformity of Vacon frequency converters with the Directive because such a large-sized product family is impossible to be tested in a laboratory environment and because the combinations of installation vary greatly.

2.2.2 *Technical criteria*

Our basic idea was to develop a range of frequency converters offering the best possible usability and cost-efficiency. EMC compliance was a major consideration from the outset of the design.

Vacon NX_ frequency converters are marketed throughout the world, a fact which makes the EMC requirements of customers different. As far as the immunity is concerned, all Vacon NX_ frequency converters are designed to fulfil even the strictest requirements, while as regards the emission level, the customer may want to upgrade Vacon's already high ability to filter electro-magnetic disturbances.

2.2.3 *Vacon frequency converter EMC classification*

Vacon NX_ frequency converters are divided into five classes according to the level of electromagnetic disturbances emitted, the requirements of a power system network and the installation environment (see chapter 2.2.3.1). The EMC class of each product is defined in the type designation code.

Vacon EMC class C (NX_5, FR4 to FR6, Protection class IP54):

Frequency converters of this class comply with the requirements of category C1 of the product standard EN 61800-3 (2004). Category C1 ensures the best EMC characteristics and it includes converters the rated voltage of which is less than 1000V and which are intended for use in the 1st environment. NOTE: If the protection class of the frequency converter is IP21 the requirements of class C are fulfilled only as far as the conducted emissions are concerned.

Vacon EMC class H (NX_5, FR4 to FR9 and NX_2, FR4 to FR9):

Frequency converters of this class comply with the requirements of category C2 of the product standard EN 61800-3 (2004). Category C2 includes converters in fixed installations and the rated voltage of which is less than 1000V. The class H frequency converters can be used both in the 1st and the 2nd environment.

Vacon EMC class L (Protection classes IP21 and IP54: NX_5 FR10 and greater, NX_6 FR6 and greater): Frequency converters of this class comply with the requirements of category C3 of the product standard EN 61800-3 (2004). Category C3 includes converters the rated voltage of which is less than 1000V and which are intended for use in the second environment only.

Vacon EMC class T:

Frequency converters of this class fulfil the product standard EN 61800-3 (2004) if intended to be used in IT systems. In IT systems, the networks are isolated from earth, or connected to earth through high impedance to achieve a low leakage current. NOTE: if converters are used with other supplies, no EMC requirements are complied with.

Vacon EMC class N:

The drives of this class do not provide EMC emission protection. These kinds of drives are mounted in enclosures. NOTE: An external EMC filter is usually required to fulfil the EMC emission requirements.

All Vacon NX_ frequency converters fulfil all EMC immunity requirements (standard EN 61800-3 (2004)).

Warning: In a domestic environment this product may cause radio interference in which case the user may be required to take adequate measures.

Note: For changing the EMC protection class of your Vacon NX_ frequency converter from class H or L to class T, please refer to the instructions given in Chapter 6.1.3.

2.2.3.1 Environment definitions in product standard EN 61800-3 (2004)

First environment: Environment that includes domestic premises. It also includes establishments directly connected without intermediate transformers to a low-voltage power supply network which supplies buildings used for domestic purposes.

NOTE: houses, apartments, commercial premises or offices in a residential building are examples of first environment locations.

Second environment: Environment that includes all establishments other than those directly connected to a low-voltage power supply network which supplies buildings used for domestic purposes.

NOTE: industrial areas, technical areas of any building fed from a dedicated transformer are examples of second environment locations.

2.2.4 *Manufacturer's declaration of conformity*

The following pages present the Manufacturer's Declarations of Conformity assuring the compliance of Vacon frequency converters with the EMC-directives.



EU DECLARATION OF CONFORMITY

We

Manufacturer's name: Vacon Oyj
Manufacturer's address: P.O.Box 25
Runsorintie 7
FIN-65381 Vaasa
Finland

hereby declare that the product

Product name: Vacon NXS/P Frequency converter
Model designation: Vacon NXS/P 0003 5.... to 1030 5....

has been designed and manufactured in accordance with the following standards:

Safety: EN 60204 -1 (2009) (as relevant)
EN 61800-5-1 (2007)

EMC: EN61800-3 (2004)

and conforms to the relevant safety provisions of the Low Voltage Directive (2006/95/EC) and EMC Directive 2004/108/EC.

It is ensured through internal measures and quality control that the product conforms at all times to the requirements of the current Directive and the relevant standards.

In Vaasa, 25th of September, 2009

A handwritten signature in black ink, appearing to read "Vesa Laisi".

Vesa Laisi
President

The year the CE marking was affixed: 2002



EU DECLARATION OF CONFORMITY

We

Manufacturer's name: Vacon Oyj
Manufacturer's address: P.O.Box 25
Runsorintie 7
FIN-65381 Vaasa
Finland

hereby declare that the product

Product name: Vacon NXS/P Frequency converter
Model designation: Vacon NXS/P 0004 6.... to 0820 6....

has been designed and manufactured in accordance with the following standards:

Safety: EN 60204 -1 (2009) (as relevant)
EN 61800-5-1 (2007)

EMC: EN61800-3 (2004)

and conforms to the relevant safety provisions of the Low Voltage Directive (2006/95/EC) and EMC Directive 2004/108/EC.

It is ensured through internal measures and quality control that the product conforms at all times to the requirements of the current Directive and the relevant standards.

In Vaasa, 25th of September, 2009

A handwritten signature in black ink, appearing to read "Vesa Laisi".

Vesa Laisi
President

The year the CE marking was affixed: 2003



EU DECLARATION OF CONFORMITY

We

Manufacturer's name: Vacon Oyj
Manufacturer's address: P.O.Box 25
Runsorintie 7
FIN-65381 Vaasa
Finland

hereby declare that the product

Product name: Vacon NXS/P Frequency converter
Model designation: Vacon NXS/P 0004 2.... to 0300 2....

has been designed and manufactured in accordance with the following standards:

Safety: EN 60204 -1 (2009) (as relevant)
EN 61800-5-1 (2007)

EMC: EN61800-3 (2004)

and conforms to the relevant safety provisions of the Low Voltage Directive (2006/95/EC) and EMC Directive 2004/108/EC.

It is ensured through internal measures and quality control that the product conforms at all times to the requirements of the current Directive and the relevant standards.

In Vaasa, 25th of September, 2009

A handwritten signature in black ink, appearing to read "Vesa Laisi".

Vesa Laisi
President

The year the CE marking was affixed: 2003

3. RECEIPT OF DELIVERY

Vacon NX_ frequency converters have undergone scrupulous tests and quality checks at the factory before they are delivered to the customer. However, after unpacking the product, check that no signs of transport damages are to be found on the product and that the delivery is complete (compare the type designation of the product to the code below, (Figure 3-1)).

Should the drive have been damaged during the shipping, please contact primarily the cargo insurance company or the carrier.

If the delivery does not correspond to your order, contact the supplier immediately.

In the small plastic bag included in the delivery you will find a silver *Drive modified* sticker. The purpose of the sticker is to notify the service personnel about the modifications made in the frequency converter. Attach the sticker on the side of the frequency converter to avoid losing it. Should the frequency converter be later modified (option board added, IP or EMC protection level changed), mark the change in the sticker.

3.1 Type designation code

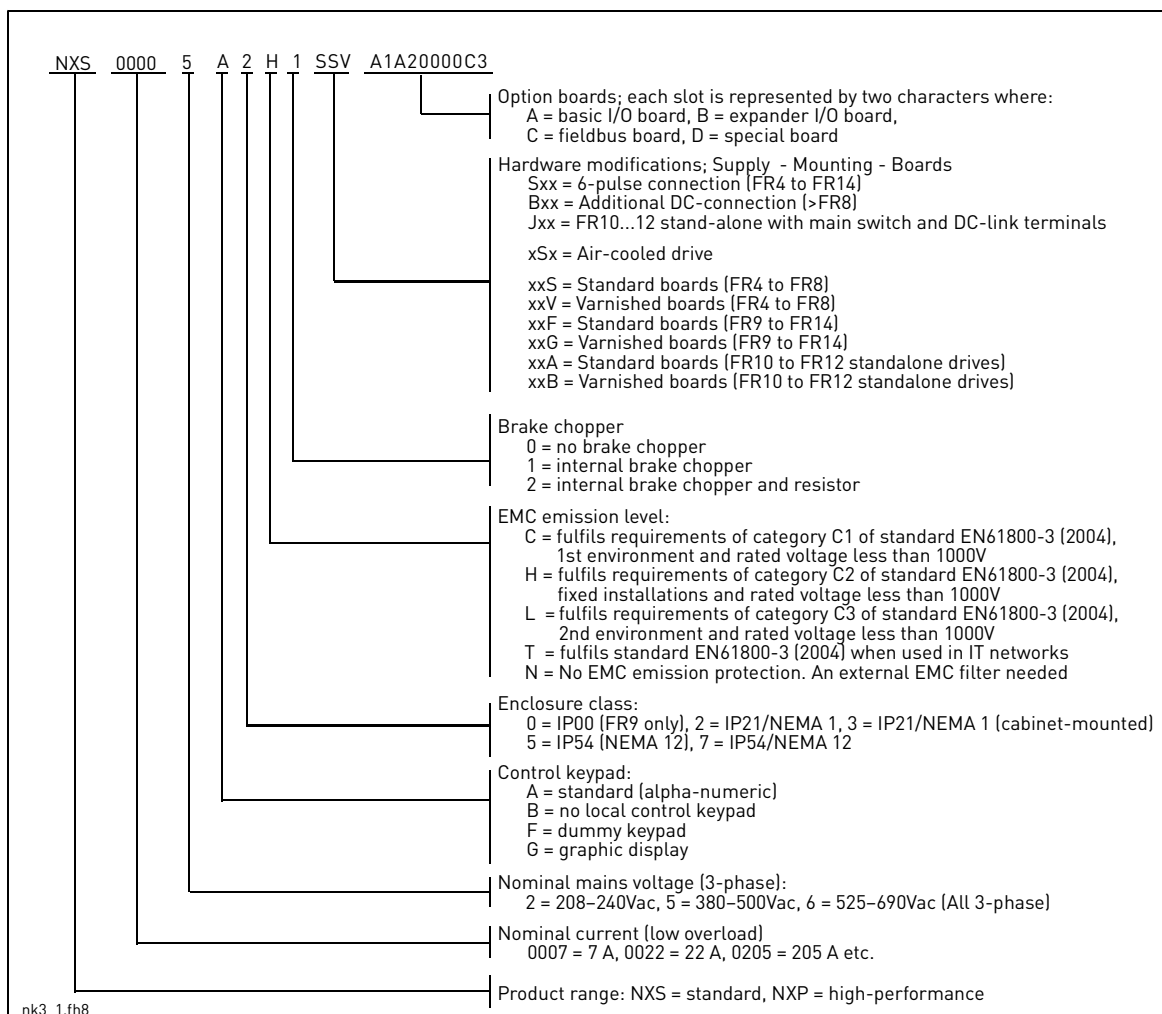

Figure 3-1. Vacon NX_ type designation code

Note: Ask factory for other possible installation combinations.

3.2 Storage

If the frequency converter is to be kept in store before use make sure that the ambient conditions are acceptable:

- Storing temperature -40...+70°C
- Relative humidity <95%, no condensation

If the converter is to be stored during longer periods power should be connected to the converter once a year and kept on for at least 2 hours. If the storage time exceeds 12 months the electrolytic DC capacitors need to be charged with caution. Therefore, such a long storage time is not recommended. If longer storage time is, however, necessary, follow the instructions in chapter 3.3.1 to recharge the capacitors.

3.3 Maintenance

In normal conditions, Vacon NX_ frequency converters are maintenance-free. However, regular maintenance is recommended to ensure a trouble-free operation and a long lifetime of the drive. We recommend to follow the table below for maintenance intervals.

Maintenance interval	Maintenance action
Whenever necessary	<ul style="list-style-type: none"> • Clean heatsink
Regularly	<ul style="list-style-type: none"> • Check tightening torques of terminals
12 months (if unit stored)	<ul style="list-style-type: none"> • Recharge capacitors (see chapter 3.3.1)
6-24 months (depending on environment)	<ul style="list-style-type: none"> • Check input and output terminals and control I/O terminals. • Clean cooling tunnel. • Check operation of cooling fan, check for corrosion on terminals, busbars and other surfaces • Check door filters in case of cabinet installation
5-7 years	<ul style="list-style-type: none"> • Change cooling fans: <ul style="list-style-type: none"> - main fan - internal IP54 fan - cabinet cooling fan/filter
5-10 years	<ul style="list-style-type: none"> • Change DC bus capacitors

Table 3-1. Maintenance intervals

3.3.1 Capacitor recharge

After a longer storage time the capacitors need to be recharged in order to avoid capacitor damage. Possible high leakage current through the capacitors must be limited. The best way to achieve this is to use a DC-power supply with adjustable current limit.

- 1) Set the current limit to 300...800mA according to the size of the drive.
- 2) Then connect the DC-power supply to the B+/B- terminals (DC+ to B+, DC- to B-) of the DC-link or directly to the capacitor terminals. NX converters with no B+/B- terminals (FR8/FR9) can be powered connecting the DC-supply between two input phases (L1 and L2).
- 3) In drives FR8 to FR12: To ensure full recharge of capacitors, remove the fuses of the cooling fan. Ask factory for further instructions if necessary.
- 4) Then set the DC-voltage to the nominal DC-voltage level of the unit (1.35*Un AC) and supply the converter for at least 1h.

If DC-voltage is not available and the unit has been stored much longer than 12 months deenergized, consult the factory before connecting power.

3.4 Warranty

Only manufacturing defects are covered by the warranty. The manufacturer assumes no responsibility for damages caused during or resulting from transport, receipt of the delivery, installation, commissioning or use.

The manufacturer shall in no event and under no circumstances be held responsible for damages and failures resulting from misuse, wrong installation, unacceptable ambient temperature, dust, corrosive substances or operation outside the rated specifications.

Neither can the manufacturer be held responsible for consequential damages.

The Manufacturer's time of warranty is 18 months from the delivery or 12 months from the commissioning whichever expires first (Vacon Warranty Terms).

The local distributor may grant a warranty time different from the above. This warranty time shall be specified in the distributor's sales and warranty terms. Vacon assumes no responsibility for any other warranties than that granted by Vacon itself.

In all matters concerning the warranty, please contact first your distributor.

4. TECHNICAL DATA

4.1 Introduction

Figure 4-1 presents the block diagram of the Vacon NX₂ frequency converter. The frequency converter mechanically consists of two units, the Power Unit and the Control Unit. Pictures of the mechanical assemblage on pages 55 to 63.

The three-phase AC-choke (1) at the mains end together with the DC-link capacitor (2) form an LC-filter, which, again, together with the diode bridge produce the DC-voltage supply to the IGBT Inverter Bridge (3) block. The AC-choke also functions as a filter against High Frequency disturbances from the mains as well as against those caused by the frequency converter to the mains. It, in addition, enhances the waveform of the input current to the frequency converter. The entire power drawn by the frequency converter from the mains is active power.

The IGBT Inverter Bridge produces a symmetrical, 3-phase PWM-modulated AC-voltage to the motor.

The Motor and Application Control Block is based on microprocessor software. The microprocessor controls the motor basing on the information it receives through measurements, parameter settings, control I/O and control keypad. The motor and application control block controls the motor control ASIC which, in turn, calculates the IGBT positions. Gate drivers amplify these signals for driving the IGBT inverter bridge.

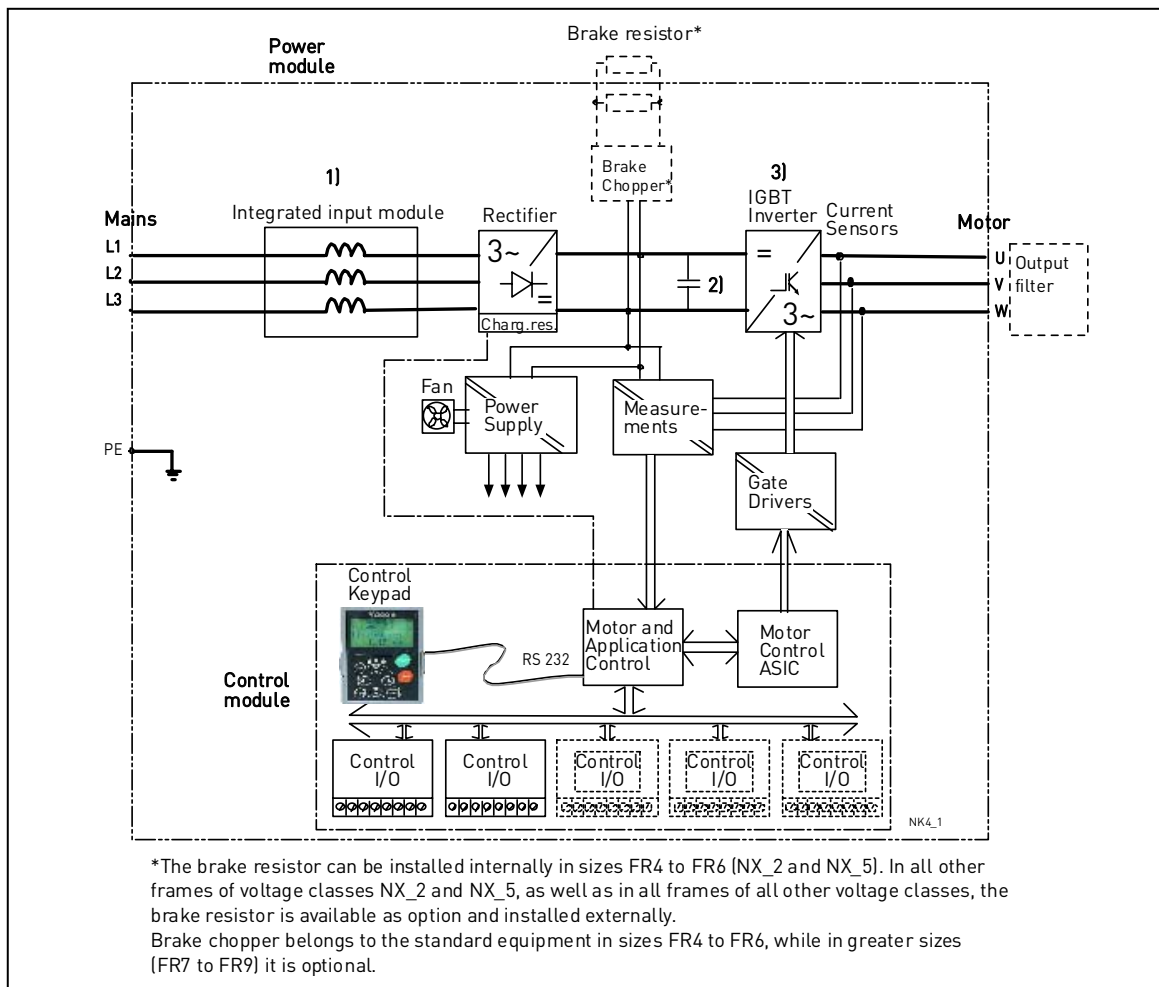

Figure 4-1 Vacon NX₂ block diagram

The control keypad constitutes a link between the user and the frequency converter. The control keypad is used for parameter setting, reading status data and giving control commands. It is detachable and can be operated externally and connected via a cable to the frequency converter. Instead of the control keypad, also a PC can be used to control the frequency converter if connected through a similar cable.

You can have your frequency converter equipped with a control I/O board which is either isolated (OPT-A8) or not isolated (OPT-A1) from the ground.

The basic control interface and the parameters (the Basic Application) are easy to use. If a more versatile interface or parameters are required, a more suitable application can be chosen from the "All in One+" Application Package. See the "All in One+" Application Manual for more information on the different applications.

A brake resistor is available as internal option for frames FR4 to FR6 of voltage classes NX_2 and NX_5. In all other frames of voltage classes NX_2 and NX_5, as well as in all frames of all other voltage classes, the brake resistor is available as option and installed externally.

Optional I/O expander boards that increase the number of inputs and outputs to be used are also available. For closer information, contact the [Manufacturer](#) or your local distributor (see back cover).

4.2 Power ratings

4.2.1 Vacon NX_5 – Mains voltage 380–500 V

High overload = Max current I_S, 2 sec/20 sec, 150% overloadability, 1 min/10 min
 Following continuous operation at rated output current, 150 % rated output current (IH) for 1 min, followed by a period of load current less than rated current, and of such duration that the r.m.s output current, over the duty cycle, does not exceed rated output current (IH)

Low overload = Max current I_S, 2 sec/20 sec, 110% overloadability, 1 min/10 min
 Following continuous operation at rated output current, 110% rated output current (IL) for 1 min, followed by a period of load current less than rated current, and of such duration that the r.m.s output current, over the duty cycle, does not exceed rated output current (IL)

All sizes are available as IP21/NEMA1 Sizes FR4 to FR10 are additionally available as IP54/NEMA12. FR12 is available only as NXP.

Mains voltage 380-500 V, 50/60 Hz, 3~											
Frequency converter type	Loadability					Motor shaft power				Frame	Dimensions and weight WxHxD/kg
	Low		High		Max current I _S	380V supply		500V supply			
	Rated continuous current I _L (A)	10% overload current (A)	Rated continuous current I _H (A)	50% overload current (A)		10% overload 40°C P(kW)	50% overload 50°C P(kW)	10% overload 40°C P(kW)	50% overload 50°C P(kW)		
NX_0003 5	3.3	3.6	2.2	3.3	4.4	1.1	0.75	1.5	1.1	FR4	128x292x190/5
NX_0004 5	4.3	4.7	3.3	5.0	6.2	1.5	1.1	2.2	1.5	FR4	128x292x190/5
NX_0005 5	5.6	6.2	4.3	6.5	8.6	2.2	1.5	3	2.2	FR4	128x292x190/5
NX_0007 5	7.6	8.4	5.6	8.4	10.8	3	2.2	4	3	FR4	128x292x190/5
NX_0009 5	9	9.9	7.6	11.4	14	4	3	5.5	4	FR4	128x292x190/5
NX_0012 5	12	13.2	9	13.5	18	5.5	4	7.5	5.5	FR4	128x292x190/5
NX_0016 5	16	17.6	12	18.0	24	7.5	5.5	11	7.5	FR5	144x391x214/8.1
NX_0022 5	23	25.3	16	24.0	32	11	7.5	15	11	FR5	144x391x214/8.1
NX_0031 5	31	34	23	35	46	15	11	18.5	15	FR5	144x391x214/8.1
NX_0038 5	38	42	31	47	62	18.5	15	22	18.5	FR6	195x519x237/18.5
NX_0045 5	46	51	38	57	76	22	18.5	30	22	FR6	195x519x237/18.5
NX_0061 5	61	67	46	69	92	30	22	37	30	FR6	195x519x237/18.5
NX_0072 5	72	79	61	92	122	37	30	45	37	FR7	237x591x257/35
NX_0087 5	87	96	72	108	144	45	37	55	45	FR7	237x591x257/35
NX_0105 5	105	116	87	131	174	55	45	75	55	FR7	237x591x257/35
NX_0140 5	140	154	105	158	210	75	55	90	75	FR8	291x758x344/58
NX_0168 5	170	187	140	210	280	90	75	110	90	FR8	291x758x344/58
NX_0205 5	205	226	170	255	336	110	90	132	110	FR8	291x758x344/58
NX_0261 5	261	287	205	308	349	132	110	160	132	FR9	480x1150x362/146
NX_0300 5	300	330	245	368	444	160	132	200	160	FR9	480x1150x362/146
NX_0385 5	385	424	300	450	540	200	160	250	200	FR10	595x2018x602/340
NX_0460 5	460	506	385	578	693	250	200	315	250	FR10	595x2018x602/340
NX_0520 5	520	572	460	690	828	250	250	355	315	FR10	595x2018x602/340
NX_0590 5	590	649	520	780	936	315	250	400	355	FR11	794x2018x602/470
NX_0650 5	650	715	590	885	1062	355	315	450	400	FR11	794x2018x602/470
NX_0730 5	730	803	650	975	1170	400	355	500	450	FR11	794x2018x602/470
NXP 0820 5	820	902	730	1095	1314	450	400	500	500	FR12	1210x2017x602/600
NXP 0920 5	920	1012	820	1230	1476	500	450	630	500	FR12	1210x2017x602/600
NXP 1030 5	1030	1133	920	1380	1656	500	500	710	630	FR12	1210x2017x602/600

Table 4-1. Power ratings and dimensions of Vacon NX_, supply voltage 380–500V.

Note: The rated currents in given ambient temperatures are achieved only when the switching frequency is equal to or less than the factory default.

Note: The rated currents for FR10 to FR12 are valid at an ambient temperature of 40°C (except for 0520 5: rated currents valid at an ambient temperature of 35°C).

4.2.2 Vacon NX₆ – Mains voltage 525–690 V

- High overload = Max current I_S, 2 sec/20 sec, 150% overloadability, 1 min/10 min
Following continuous operation at rated output current, 150 % rated output current (IH) for 1 min, followed by a period of load current less than rated current, and of such duration that the r.m.s output current, over the duty cycle, does not exceed rated output current (IH)
- Low overload = Max current I_S, 2 sec/20 sec, 110% overloadability, 1 min/10 min
Following continuous operation at rated output current, 110% rated output current (IL) for 1 min, followed by a period of load current less than rated current, and of such duration that the r.m.s output current, over the duty cycle, does not exceed rated output current (IL)

All sizes are available as IP21/NEMA1 Sizes FR4 to FR10 are additionally available as IP54/NEMA12. FR12 is available only as NXP.

Mains voltage 525-690 V, 50/60 Hz, 3~											
Frequency converter type	Loadability					Motor shaft power				Frame	Dimensions and weight WxHxD/kg
	Low		High		Max current I _S	690V supply		575V supply			
	Rated continuous current I _L (A)	10% overload current (A)	Rated continuous current I _H (A)	50% overload current (A)		10% overload 40°C P(kW)	50% overload 50°C P(kW)	10% overload 40°C P(hp)	50% overload 50°C P(hp)		
NX_0004 6	4.5	5.0	3.2	4.8	6.4	3	2.2	3.0	2.0	FR6	195x519x237/18,5
NX_0005 6	5.5	6.1	4.5	6.8	9.0	4	3	3.0	3.0	FR6	195x519x237/18,5
NX_0007 6	7.5	8.3	5.5	8.3	11.0	5.5	4	5.0	3.0	FR6	195x519x237/18,5
NX_0010 6	10	11.0	7.5	11.3	15.0	7.5	5.5	7.5	5.0	FR6	195x519x237/18,5
NX_0013 6	13.5	14.9	10	15.0	20.0	10	7.5	11	7.5	FR6	195x519x237/18,5
NX_0018 6	18	19.8	13.5	20.3	27	15	10	15	11	FR6	195x519x237/18,5
NX_0022 6	22	24.2	18	27.0	36	18.5	15	20	15	FR6	195x519x237/18,5
NX_0027 6	27	29.7	22	33.0	44	22	18.5	25	20	FR6	195x519x237/18,5
NX_0034 6	34	37	27	41	54	30	22	30	25	FR6	195x519x237/18,5
NX_0041 6	41	45	34	51	68	37.5	30	40	30	FR7	237x591x257/35
NX_0052 6	52	57	41	62	82	45	37.5	50	40	FR7	237x591x257/35
NX_0062 6	62	68	52	78	104	55	45	60	50	FR8	291x758x344/58
NX_0080 6	80	88	62	93	124	75	55	75	60	FR8	291x758x344/58
NX_0100 6	100	110	80	120	160	90	75	100	75	FR8	291x758x344/58
NX_0125 6	125	138	100	150	200	110	90	125	100	FR9	480x1150x362/146
NX_0144 6	144	158	125	188	213	132	110	150	125	FR9	480x1150x362/146
NX_0170 6	170	187	144	216	245	160	132	150	150	FR9	480x1150x362/146
NX_0208 6	208	229	170	255	289	200	160	200	150	FR9	480x1150x362/146
NX_0261 6	261	287	208	312	375	250	200	250	200	FR10	595x2018x602/340
NX_0325 6	325	358	261	392	470	315	250	300	250	FR10	595x2018x602/340
NX_0385 6	385	424	325	488	585	355	315	400	300	FR10	595x2018x602/340
NX_0416 6	416	458	325	488	585	400	315	450	300	FR10	595x2018x602/340
NX_0460 6	460	506	385	578	693	450	355	450	400	FR11	794x2018x602/400
NX_0502 6	502	552	460	690	828	500	450	500	450	FR11	794x2018x602/400
NX_0590 6	590	649	502	753	904	560	500	600	500	FR11	794x2018x602/470
NXP 0650 6	650	715	590	885	1062	630	560	650	600	FR12	1210x2017x602/600
NXP 0750 6	750	825	650	975	1170	710	630	800	650	FR12	1210x2017x602/600
NXP 0820 6	820	902	650	975	1170	800	630	800	650	FR12	1210x2017x602/600

Table 4-2. Power ratings and dimensions of Vacon NX₆, supply voltage 525–690V.

Note: The rated currents in given ambient temperatures are achieved only when the switching frequency is equal to or less than the factory default.

Note: The rated currents for FR10 to FR12 are valid at an ambient temperature of 40°C (except for 0416 6, 0590 6 and 0820 6: rated currents valid at an ambient temperature of 35°C).

4.2.3 Vacon NXS2 – Mains voltage 208—240 V

- High overload = Max current I_S, 2 sec/20 sec, 150% overloadability, 1 min/10 min
Following continuous operation at rated output current, 150 % rated output current (IH) for 1 min, followed by a period of load current less than rated current, and of such duration that the r.m.s output current, over the duty cycle, does not exceed rated output current (IH)
- Low overload = Max current I_S, 2 sec/20 sec, 110% overloadability, 1 min/10 min
Following continuous operation at rated output current, 110% rated output current (IL) for 1 min, followed by a period of load current less than rated current, and of such duration that the r.m.s output current, over the duty cycle, does not exceed rated output current (IL)

All sizes are available as IP21/NEMA1 or IP54/NEMA12.

Mains voltage 208-240 V, 50/60 Hz, 3~											
Frequency converter type	Loadability					Motor shaft power				Frame	Dimensions and weight WxHxD/kg
	Low		High			230V supply		208-240V supply			
	Rated continuous current I _L (A)	10% overload current (A)	Rated continuous current I _H (A)	50% overload current (A)	Max current I _S	10% overload 40°C P(kW)	50% overload 50°C P(kW)	10% overload 40°C P(hp)	50% overload 50°C P(hp)		
NXS 0004 2	4.8	5.3	3.7	5.6	7.4	0.75	0.55	1	0.75	FR4	128x292x190/5
NXS 0007 2	6.6	7.3	4.8	7.2	9.6	1.1	0.75	1.5	1	FR4	128x292x190/5
NXS 0008 2	7.8	8.6	6.6	9.9	13.2	1.5	1.1	2	1.5	FR4	128x292x190/5
NXS 0011 2	11	12.1	7.8	11.7	15.6	2.2	1.5	3	2	FR4	128x292x190/5
NXS 0012 2	12.5	13.8	11	16.5	22	3	2.2	-	3	FR4	128x292x190/5
NXS 0017 2	17.5	19.3	12.5	18.8	25	4	3	5	-	FR5	144x391x214/8,1
NXS 0025 2	25	27.5	17.5	26.3	35	5.5	4	7.5	5	FR5	144x391x214/8,1
NXS 0031 2	31	34.1	25	37.5	50	7.5	5.5	10	7.5	FR5	144x391x214/8,1
NXS 0048 2	48	52.8	31	46.5	62	11	7.5	15	10	FR6	195x519x237/18,5
NXS 0061 2	61	67.1	48	72.0	96	15	11	20	15	FR6	195x519x237/18,5
NXS 0075 2	75	83	61	92	122	22	15	25	20	FR7	237x591x257/35
NXS 0088 2	88	97	75	113	150	22	22	30	25	FR7	237x591x257/35
NXS 0114 2	114	125	88	132	176	30	22	40	30	FR7	237x591x257/35
NXS 0140 2	140	154	105	158	210	37	30	50	40	FR8	291x758x344/58
NXS 0170 2	170	187	140	210	280	45	37	60	50	FR8	291x758x344/58
NXS 0205 2	205	226	170	255	336	55	45	75	60	FR8	291x758x344/58
NXS 0261 2	261	287	205	308	349	75	55	100	75	FR9	480x1150x362/146
NXS 0300 2	300	330	245	368	444	90	75	125	100	FR9	480x1150x362/146

Table 4-3. Power ratings and dimensions of Vacon NXS, supply voltage 208—240V.

Note: The rated currents in given ambient temperatures are achieved only when the switching frequency is equal to or less than the factory default.

4.3 Brake resistor ratings

Mains voltage 380-500 V, 50/60 Hz, 3~					
Converter type	Max. brake current [I]	Resistor nom [ohm]	Converter type	Max. brake current [I]	Resistor nom. [ohm]
NX_0003 5	12	63	NX_0105 5	111	6.5
NX_0004 5	12	63	NX_0140 5	222	3.3
NX_0005 5	12	63	NX_0168 5	222	3.3
NX_0007 5	12	63	NX_0205 5	222	3.3
NX_0009 5	12	63	NX_0261 5	222	3.3
NX_0012 5	12	63	NX_0300 5	222	3.3
NX_0016 5	12	63	NX_0385 5	570	1,4
NX_0022 5	12	63	NX_0460 5	570	1,4
NX_0031 5	17	42	NX_0520 5	570	1,4
NX_0038 5	35	21	NX_0590 5	855	0,9
NX_0045 5	35	21	NX_0650 5	855	0,9
NX_0061 5	51	14	NX_0730 5	855	0,9
NX_0072 5	111	6.5	NX_0820 5	2 x 570	2 x 1,4
NX_0087 5	111	6.5	NX_0920 5	2 x 570	2 x 1,4

Table 4-4. Brake resistor ratings, Vacon NX_, supply voltage 380-500V

Mains voltage 525-690 V, 50/60 Hz, 3~					
Converter type	Max. brake current [I]	Resistor nom [ohm]	Converter type	Max. brake current [I]	Resistor nom. [ohm]
NX_0004 6	11	100	NX_0125 6	157.1	7
NX_0005 6	11	100	NX_0144 6	157.1	7
NX_0007 6	11	100	NX_0170 6	157.1	7
NX_0010 6	11	100	NX_0208 6	157.1	7
NX_0013 6	11	100	NX_0261 6	440.0	2.5
NX_0018 6	36.7	30	NX_0325 6	440.0	2.5
NX_0022 6	36.7	30	NX_0385 6	440.0	2.5
NX_0027 6	36.7	30	NX_0416 6	440.0	2.5
NX_0034 6	36.7	30	NX_0460 6	647.1	1.7
NX_0041 6	61.1	18	NX_0502 6	647.1	1.7
NX_0052 6	61.1	18	NX_0590 6	647.1	1.7
NX_0062 6	122.2	9	NX_0650 6	2 x 440	2 x 2.5
NX_0080 6	122.2	9	NX_0750 6	2 x 440	2 x 2.5
NX_0100 6	122.2	9	NX_0820 6	2 x 440	2 x 2.5

Table 4-5. Brake resistor ratings, Vacon NX_, supply voltage 525-690V

Mains voltage 208-240 V, 50/60 Hz, 3~						
Converter type	Max. brake current [I]	Resistor nom [ohm]		Converter type	Max. brake current [I]	Resistor nom. [ohm]
NXS 0004 2	15	30		NXS 0061 2	46	10
NXS 0007 2	15	30		NXS 0075 2	148	3.3
NXS 0008 2	15	30		NXS 0088 2	148	3.3
NXS 0011 2	15	30		NXS 0114 2	148	3.3
NXS 0012 2	15	30		NXS 0140 2	296	1.4
NXS 0017 2	15	30		NXS 0170 2	296	1.4
NXS 0025 2	15	30		NXS 0205 2	296	1.4
NXS 0031 2	23	20		NXS 0261 2	296	1.4
NXS 0048 2	46	10		NXS 0300 2	296	1.4

Table 4-6. Brake resistor ratings, Vacon NXS, supply voltage 208-240V

4.4 Technical data

Mains connection	Input voltage U_{in}	208...240V; 380...500V; 525...690V; -15%...+10%
	Input frequency	45...66 Hz
	Connection to mains	Once per minute or less
	Starting delay	2 s (FR4 to FR8); 5 s (FR9)
Motor connection	Output voltage	$0-U_{in}$
	Continuous output current	I_H : Ambient temperature max. +50°C, overload 1.5 x I_H (1 min./10 min.) I_L : Ambient temperature max. +40°C, overload 1.1 x I_L (1 min./10 min.)
	Starting current	I_S for 2 s every 20 s
	Output frequency	0...320 Hz (standard); 7200 Hz (special software)
	Frequency resolution	0.01 Hz (NXS); Application dependent (NXP)
	Control characteristics	Control method
Switching frequency (see parameter 2.6.9)		NXS2/NX_5: Up to NX_0061: 1...16 kHz; Default: 10 kHz NXS2: NX_0075 and greater: 1...10 kHz; Def: 3.6 kHz NX_5: NX_0072 and greater: 1...6 kHz; Def: 3.6 kHz NX_6: 1...6 kHz; Default: 1.5 kHz
<u>Frequency reference</u>		
Analogue input		Resolution 0.1% (10-bit), accuracy ±1%
Panel reference		Resolution 0.01 Hz
Field weakening point		8...320 Hz
Acceleration time		0.1...3000 sec
Deceleration time		0.1...3000 sec
Braking torque		DC brake: 30% * T_N (without brake option)
Ambient conditions		Ambient operating temperature
	Storage temperature	-40°C...+70°C
	Relative humidity	0 to 95% RH, non-condensing, non-corrosive, no dripping water
	Air quality: - chemical vapours - mechanical particles	IEC 721-3-3, unit in operation, class 3C2 IEC 721-3-3, unit in operation, class 3S2
	Altitude	100% load capacity (no derating) up to 1,000 m 1-% derating for each 100m above 1,000m. Max. altitudes: NXS2: 3,000m; NX_5 (380...400V): 3,000m; NX_5 (415...500): 2,000m; NX_6: 2,000m
	Vibration EN50178/EN60068-2-6	5...150 Hz Displacement amplitude 1 mm (peak) at 5...15.8 Hz (FR4...9) Max acceleration amplitude 1 G at 15.8...150 Hz (FR4...FR9) Displacement amplitude 0.25 mm (peak) at 5-31 Hz (FR10...12) Max acceleration amplitude 0.25 G at 31...150 Hz (FR10...12)
	Shock EN50178, EN60068-2-27	UPS Drop Test (for applicable UPS weights) Storage and shipping: max 15 G, 11 ms (in package)

	Enclosure class	IP21/NEMA1 standard in entire kW/HP range IP54/NEMA12 option in FR4 to FR10 Note! Keypad required for IP54/NEMA12			
EMC (at default settings)	Immunity	Fulfil EN61800-3 (2004), first and second environment			
	Emissions	Depend on EMC level. See chapters 2 and 3.			
Safety		EN 61800-5-1 (2003), CE, cUL, C-TICK; (see unit nameplate for more detailed approvals)			
Emissions	Average noise level (cooling fan) in dB (A)	FR4	44	FR9	76
		FR5	49	FR10	76
		FR6	57	FR11	76
		FR7	57	FR12	76
		FR8	58		
Control connections (apply to boards OPT-A1, OPT-A2 and OPT-A3)	Analogue input voltage	0...+10V, R _i = 200kΩ, (-10V...+10V joystick control) Resolution 0.1%, accuracy ±1%			
	Analogue input current	0(4)...20 mA, R _i = 250Ω differential			
	Digital inputs (6)	Positive or negative logic; 18...30VDC			
	Auxiliary voltage	+24V, ±10%, max volt. ripple < 100mVrms; max. 250mA Dimensioning: max. 1000mA/control box			
	Output reference voltage	+10V, +3%, max. load 10mA			
	Analogue output	0(4)...20mA; R _L max. 500Ω; Resolution 10 bit; Accuracy ±2%			
	Digital outputs	Open collector output, 50mA/48V			
	Relay outputs	2 programmable change-over relay outputs Switching capacity: 24VDC/8A, 250VAC/8A, 125VDC/0.4A Min.switching load: 5V/10mA			
Protections	Overvoltage trip limit	NXS2: 437VDC; NX_5: 911VDC; NX_6: 1200VDC			
	Undervoltage trip limit	NXS2: 183VDC; NX_5: 333VDC; NX_6: 460 VDC			
	Earth fault protection	In case of earth fault in motor or motor cable, only the frequency converter is protected			
	Mains supervision	Trips if any of the input phases is missing			
	Motor phase supervision	Trips if any of the output phases is missing			
	Overcurrent protection	Yes			
	Unit overtemperature protection	Yes			
	Motor overload protection	Yes			
	Motor stall protection	Yes			
Motor underload protection	Yes				
Short-circuit protection of +24V and +10V reference voltages	Yes				

Table 4-7. Technical data

5. INSTALLATION

5.1 Mounting

The frequency converter can be mounted in either vertical or horizontal position on the wall or on the back plane of a cubicle. However, if the drive is mounted in a horizontal position, **it is not protected against vertically falling drops of water.**

Enough space shall be reserved around the frequency converter in order to ensure a sufficient cooling, see Figure 5-11, Table 5-10 and Table 5-11. Also see to that the mounting plane is relatively even.

The frequency converter shall be fixed with four screws (or bolts, depending on the unit size). The dimensions of installation are presented in Figure 5-11 and Table 5-10.

Lift units bigger than FR7 out of the package using a jib crane. Ask the factory or your local distributor for information on how to lift the unit safely.

Below you will find the dimensions of both wall-mounted as well as flange-mounted Vacon NX_ frequency converters. The dimensions of the opening needed in flange mounting are given in Table 5-3 and Table 5-5.

The sizes FR10 to FR12 are floorstanding units. The enclosures are equipped with fixing holes. For dimensions see below.

See also chapter 5.2 Cooling.

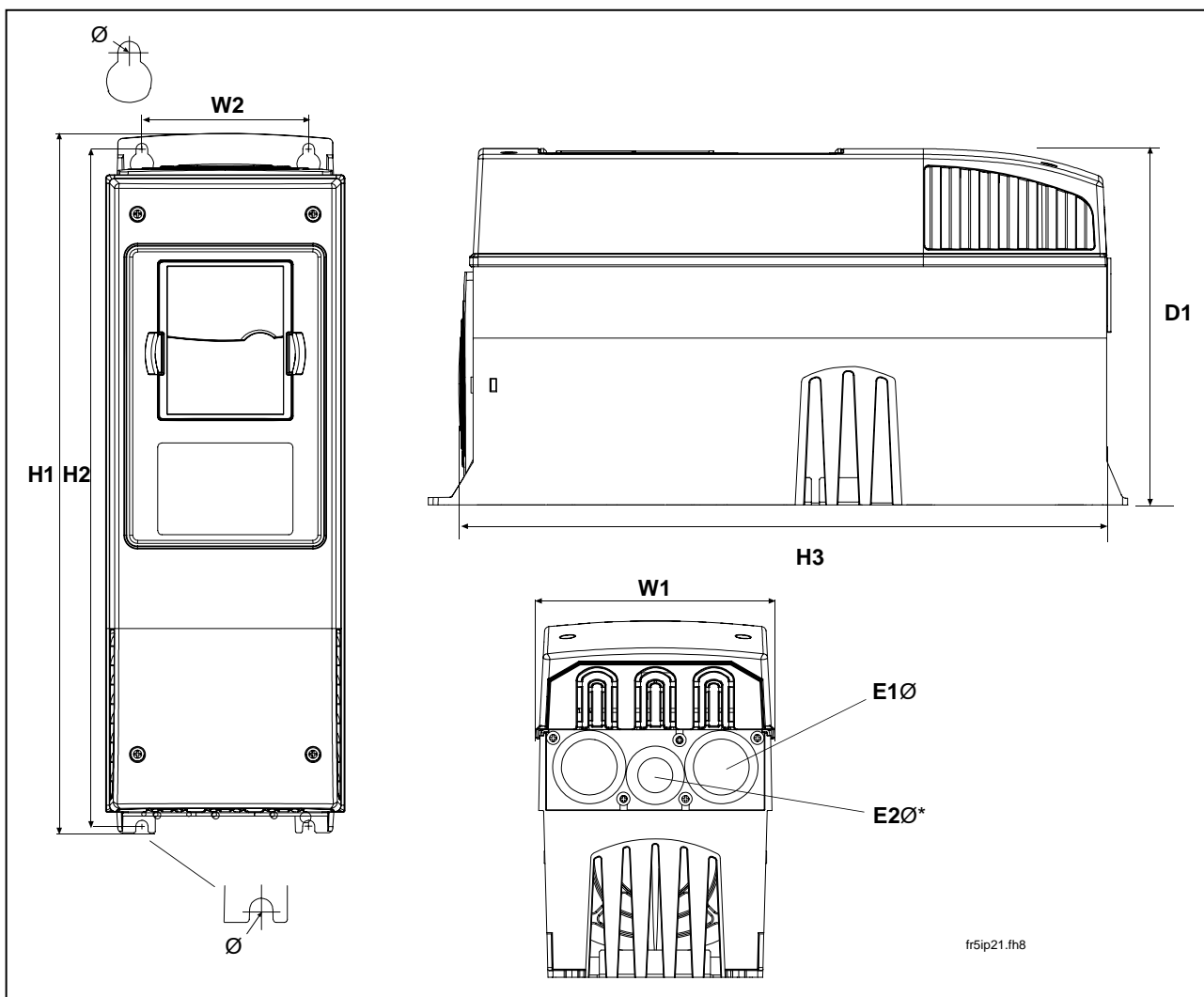

Figure 5-1. Vacon NX_ dimensions

Type	Dimensions [mm]								
	W1	W2	H1	H2	H3	D1	\varnothing	E1 \varnothing	E2 \varnothing^*
0004—0012 NXS2 0003—0012 NX_5	128	100	327	313	292	190	7	3 x 28,3	
0017—0031 NXS2 0016—0031 NX_5	144	100	419	406	391	214	7	2 x 37	1 x 28,3
0048—0061 NXS2 0038—0061 NX_5 0004—0034 NX_6	195	148	558	541	519	237	9	3 x 37	
0075—0114 NXS2 0072—0105 NX_5 0041—0052 NX_6	237	190	630	614	591	257	9	3 x 47	
0140—0205 NXS2 0140—0205 NX_5 0062—0100 NX_6	289	255	759	732	721	344	9	3 x 59	

Table 5-1. Dimensions for different frequency converter types

* = FR5 only

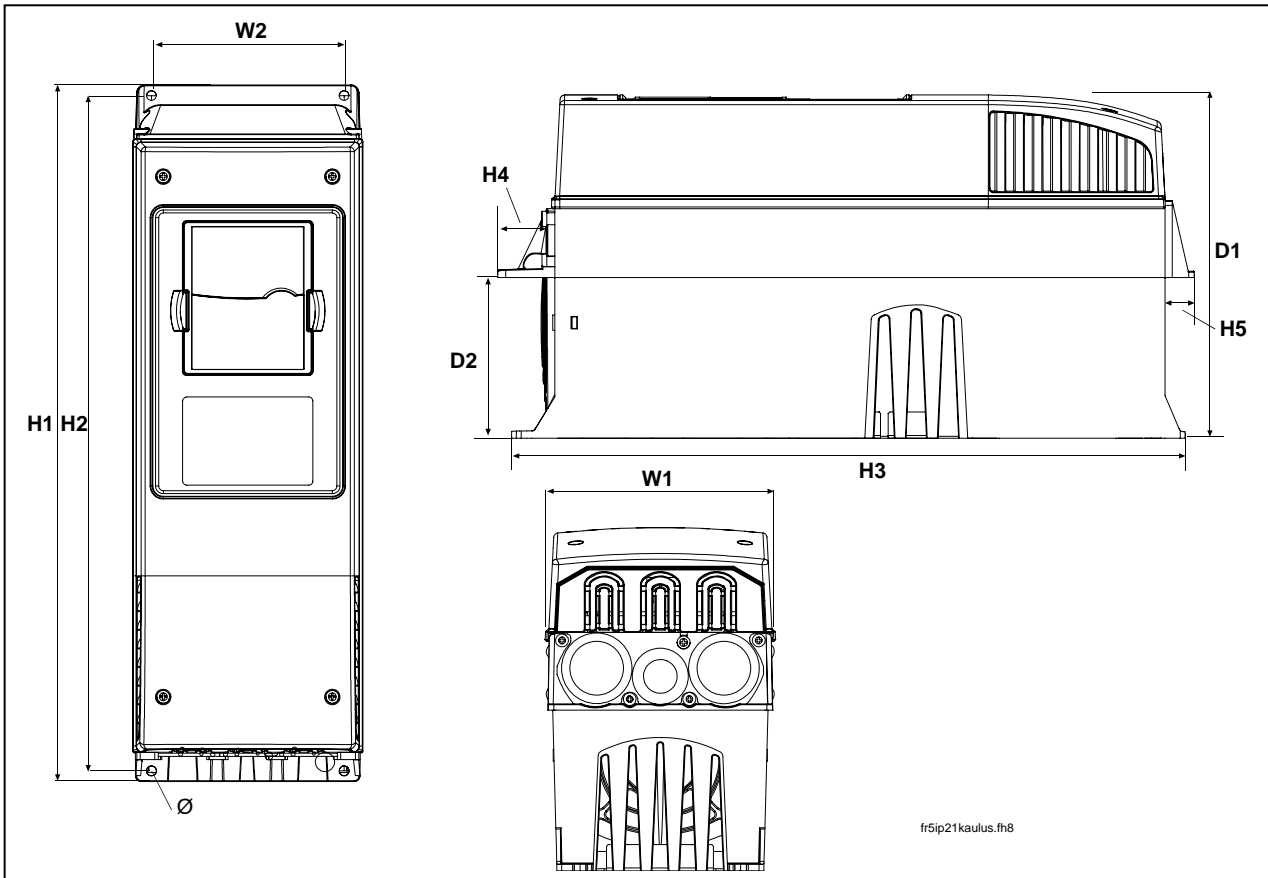

Figure 5-2. Vacon NX_ dimensions, FR4 to FR6; Flange mounting

Type	Dimensions [mm]									
	W1	W2	H1	H2	H3	H4	H5	D1	D2	Ø
0004—0012 NXS2 0003—0012 NX_5	128	113	337	325	327	30	22	190	77	7
0017—0031 NXS2 0016—0031 NX_5	144	120	434	420	419	36	18	214	100	7
0048—0061 NXS2 0038—0061 NX_5 0004—0034 NX_6	195	170	560	549	558	30	20	237	106	6.5

Table 5-2. Dimensions for different frequency converter types FR4 to FR6, flange mounting

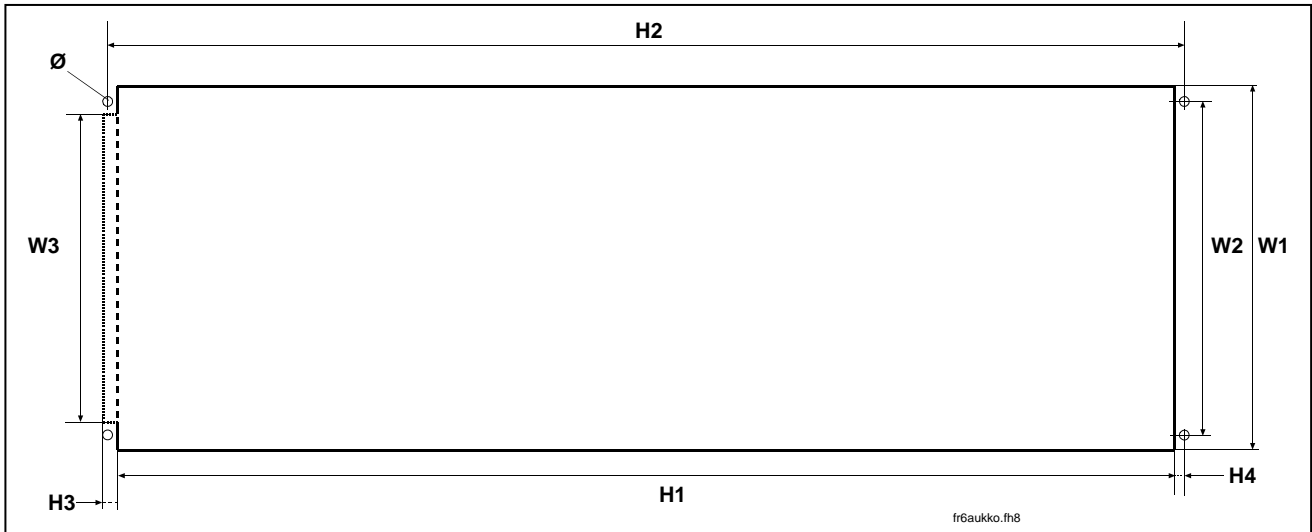

Figure 5-3. The opening needed for the flange mounting, FR4 to FR6

Type	Dimensions [mm]							
	W1	W2	W3	H1	H2	H3	H4	Ø
0004—0012 NXS2 0003—0012 NX_5	123	113	-	315	325	-	5	6.5
0017—0031 NXS2 0016—0031 NX_5	135	120	-	410	420	-	5	6.5
0048—0061 NXS2 0038—0061 NX_5 0004—0034 NX_6	185	170	157	539	549	7	5	6.5

Table 5-3. Dimensions for the opening for flange mounting, FR4 to FR6

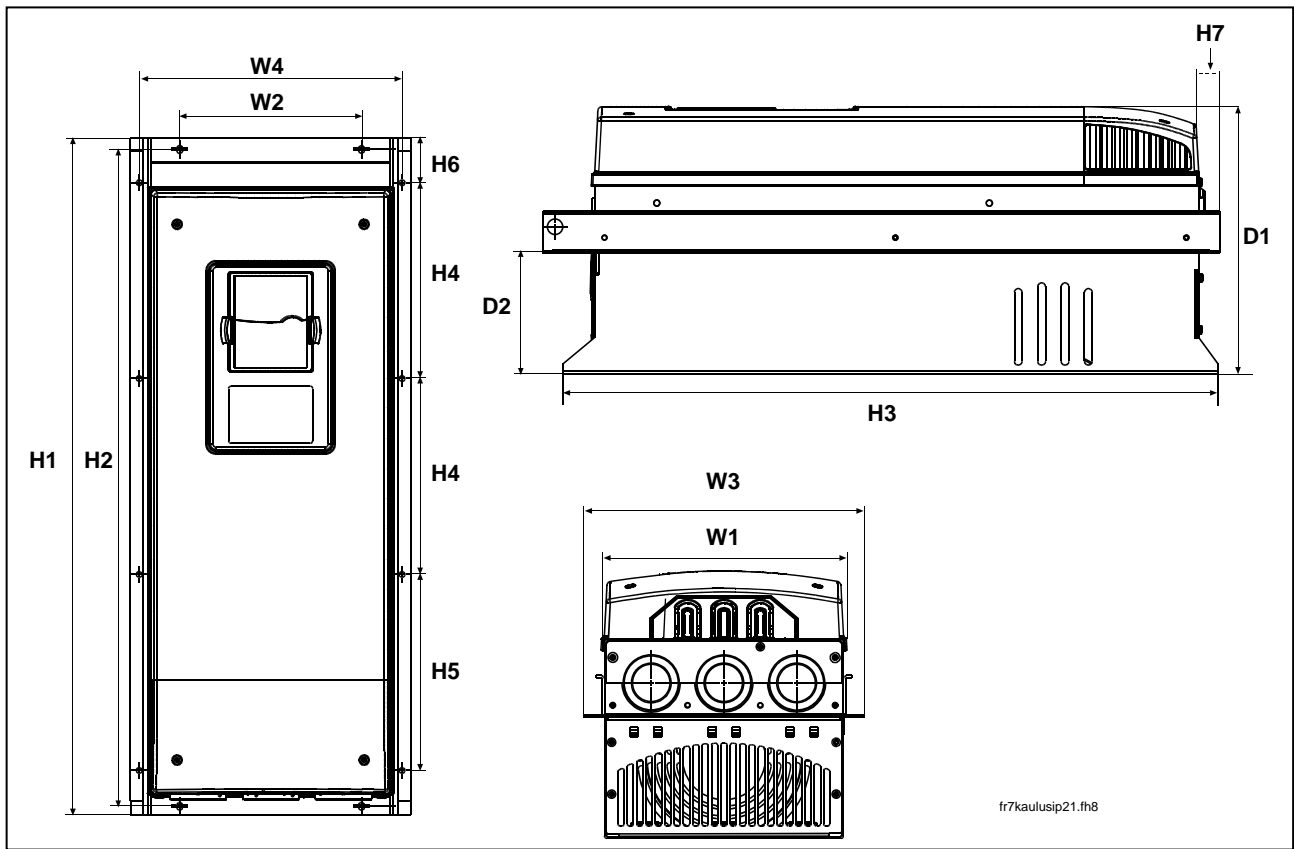

Figure 5-4. Vacon NX_ dimensions, FR7 and FR8, flange mounting

Type	Dimensions [mm]													
	W1	W2	W3	W4	H1	H2	H3	H4	H5	H6	H7	D1	D2	Ø
0075—0114 NXS2 0072—0105 NX_5 0041—0052 NX_6	237	175	270	253	652	632	630	188.5	188.5	23	20	257	117	5.5
0140—0205 NXS2 0140—0205 NX_5 0062—0100 NX_6	289	-	355	330	832*	-	759	258	265	43	57	344	110	9

Table 5-4. Dimensions for different frequency converter types FR7 and FR8, flange mounting

*Brake resistor terminal box (202.5 mm) not included, see page 61

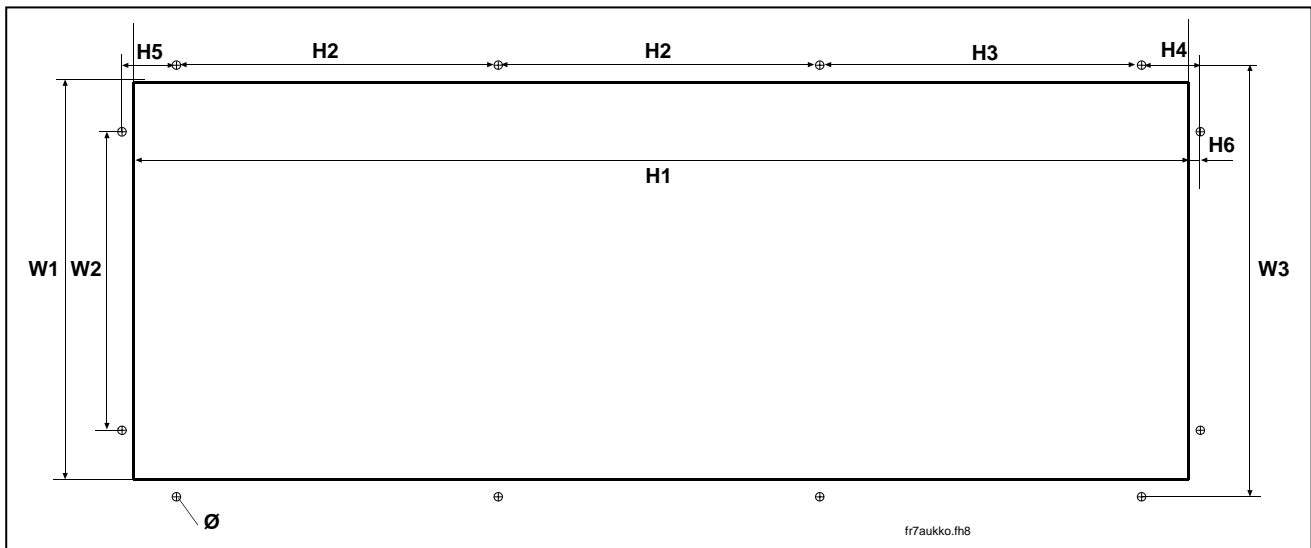

Figure 5-5. The opening needed for the flange mounting, FR7

Type	Dimensions [mm]									
	W1	W2	W3	H1	H2	H3	H4	H5	H6	Ø
0075—0114 NXS2 0072—0105 NX_5 0041—0052 NX_6	233	175	253	619	188.5	188.5	34.5	32	7	5.5

Table 5-5. Dimensions for the opening for flange mounting, FR7

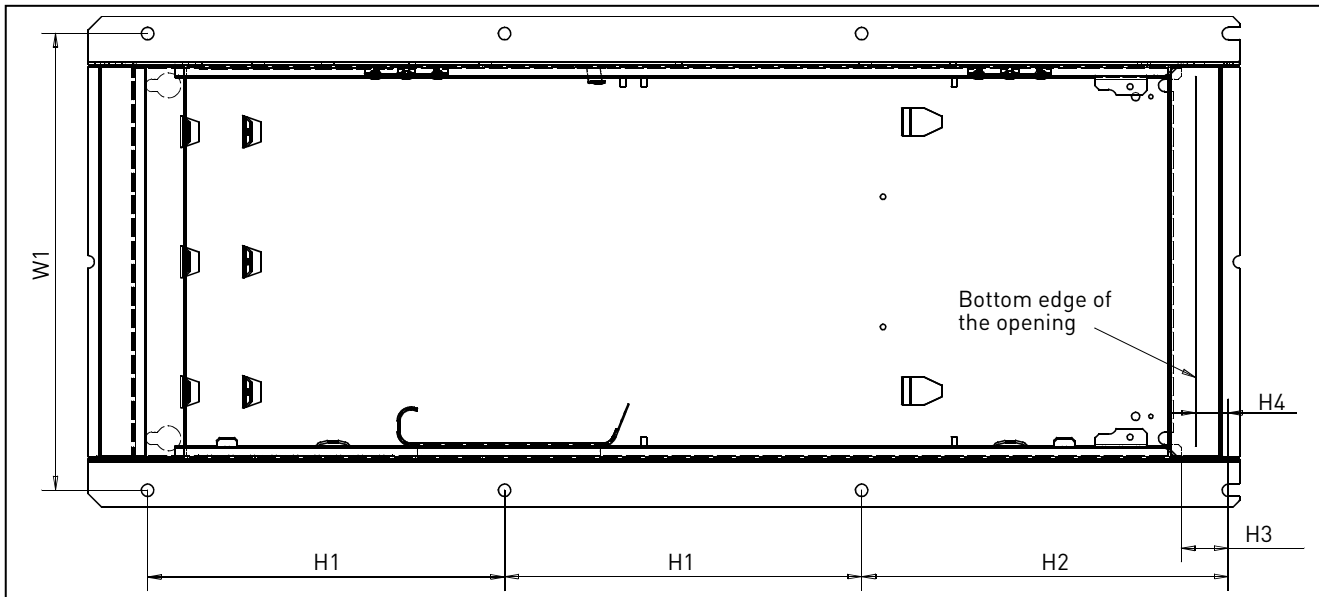

Figure 5-6. The opening needed for the flange mounting, FR8

Type	Dimensions [mm]					
	W1	H1	H2	H3	H4	Ø
0140—0205 NXS2 0140—0205 NX_5 0062—0100 NX_6	330	258	265	34	24	9

Table 5-6. Dimensions for the opening for flange mounting, FR8

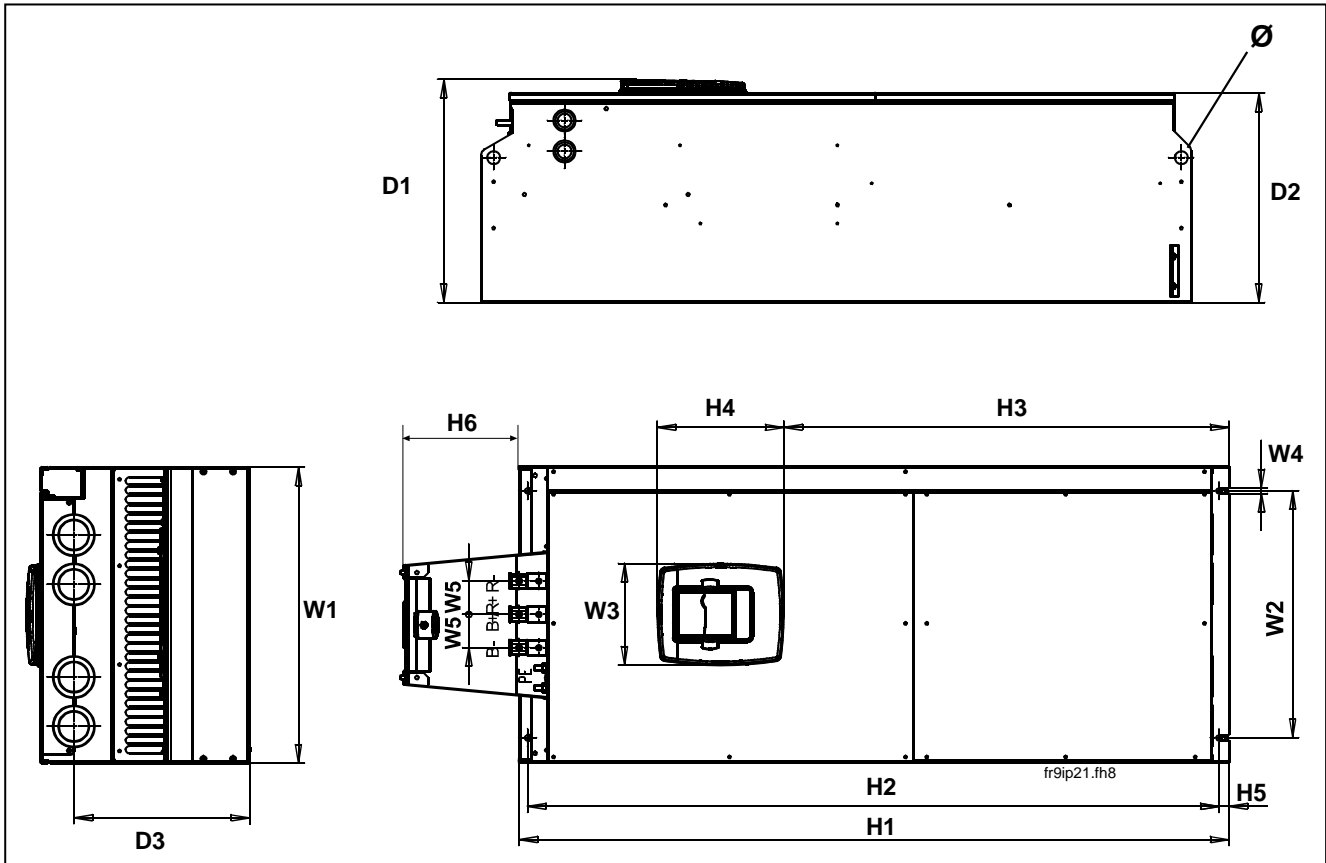

Figure 5-7. The dimensions Vacon NX_, FR9

Type	Dimensions [mm]														
	W1	W2	W3	W4	W5	H1	H2	H3	H4	H5	H6	D1	D2	D3	Ø
0261—0300 NXS2															
0261—0300 NX_5	480	400	165	9	54	1150*	1120	721	205	16	188	362	340	285	21
0125—0208 NX_6															

Table 5-7. The dimensions Vacon NX_, FR9

*Brake resistor terminal box (H6) not included, see page 61.

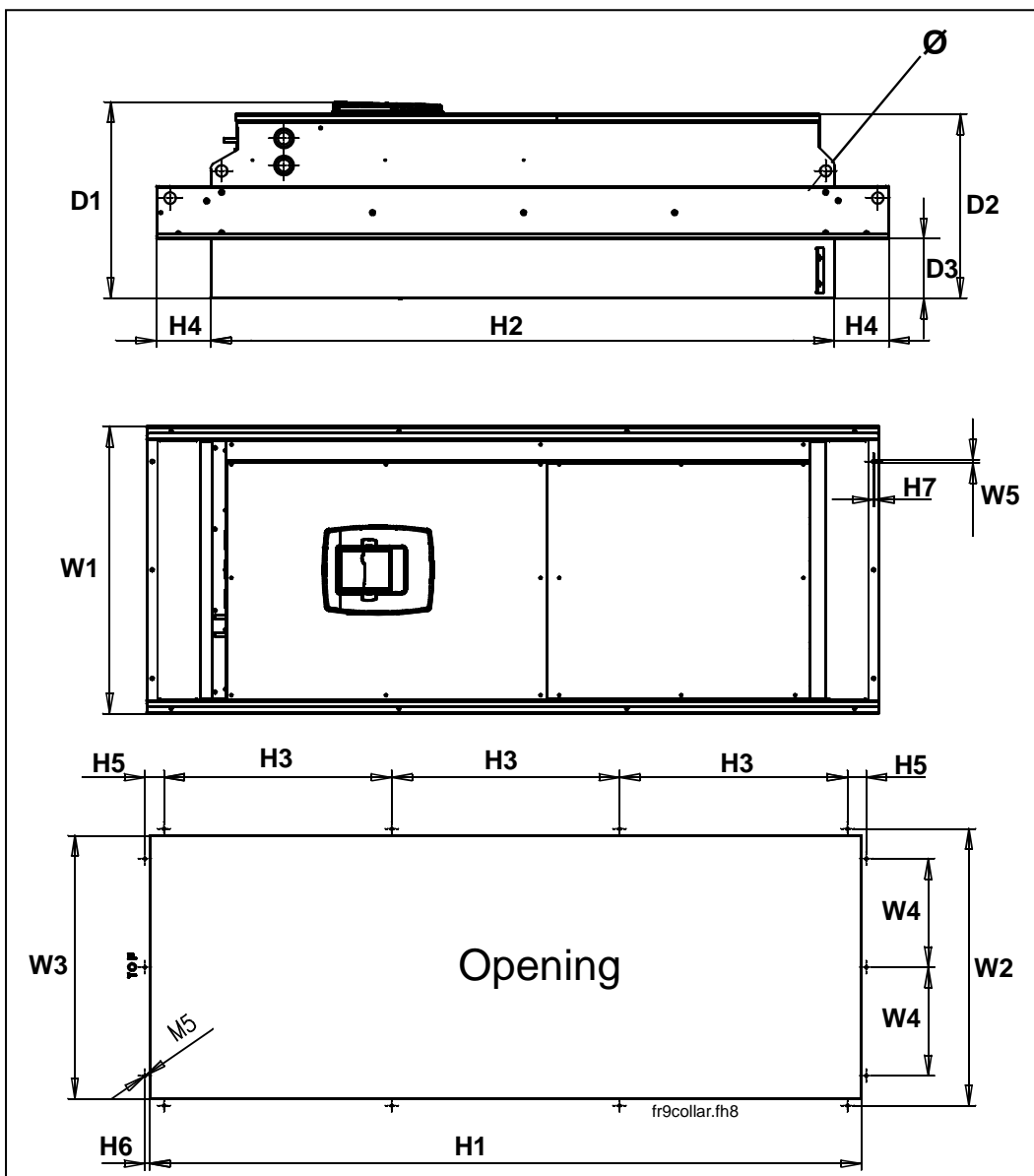

Figure 5-8. Vacon NX_ dimensions. FR9 flange mounting

Type	Dimensions [mm]															
	W1	W2	W3	W4	W5	H1	H2	H3	H4	H5	H6	H7	D1	D2	D3	∅
0261-0300 NXS2 0261-0300 NX_5 0125-0208 NX_6	530	510	485	200	5.5	1312	1150	420	100	35	9	2	362	340	109	21

Table 5-8. Vacon NX_ dimensions. FR9 flange-mounted

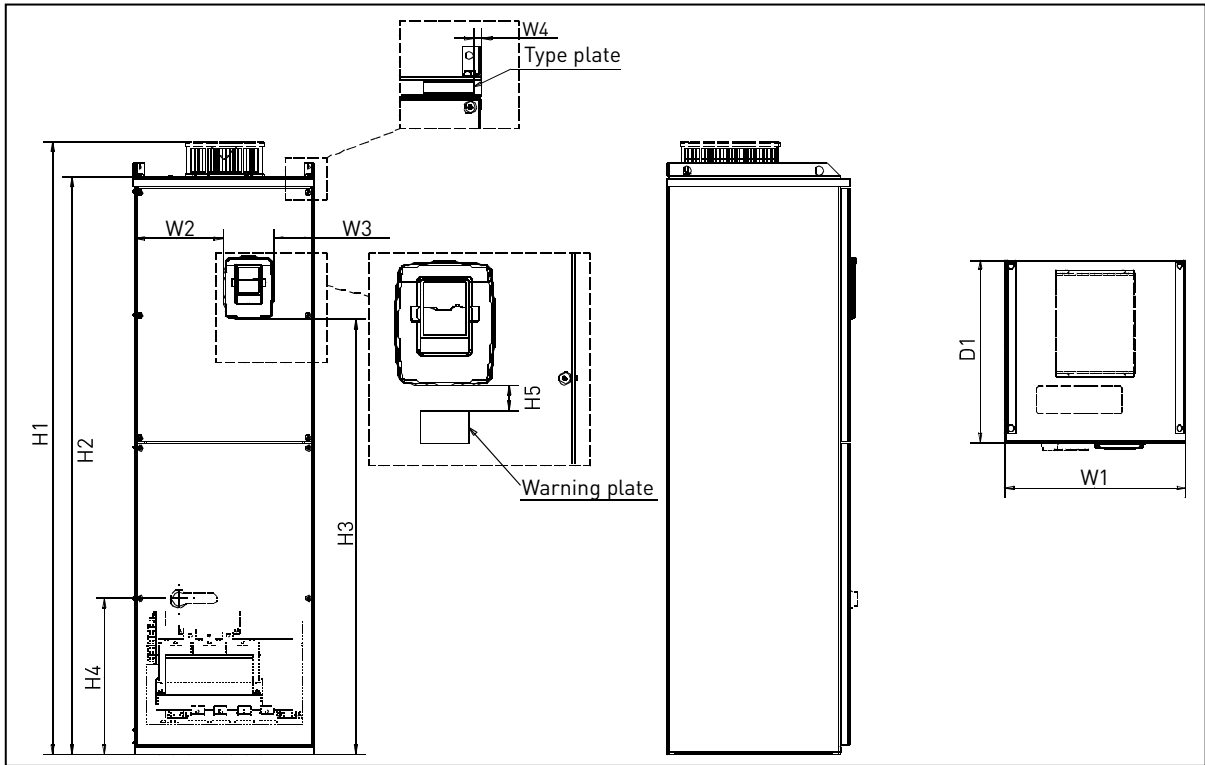

Figure 5-9. Vacon NX_ dimensions, FR10 and FR11 (floorstanding units)

Type	Dimensions [mm]									
	W1	W2	W3	W4	H1	H2	H3	H4	H5	D1
0385...0520 NX_5 0261...0416 NX_6	595	291	131	15	2018	1900	1435	512	40	602
0590...0730 NX_5 0460...0590 NX_6	794	390	230	15	2018	1900	1435	512	40	602

Table 5-9. Vacon NX_ dimensions, FR10 and FR11 (floorstanding units)

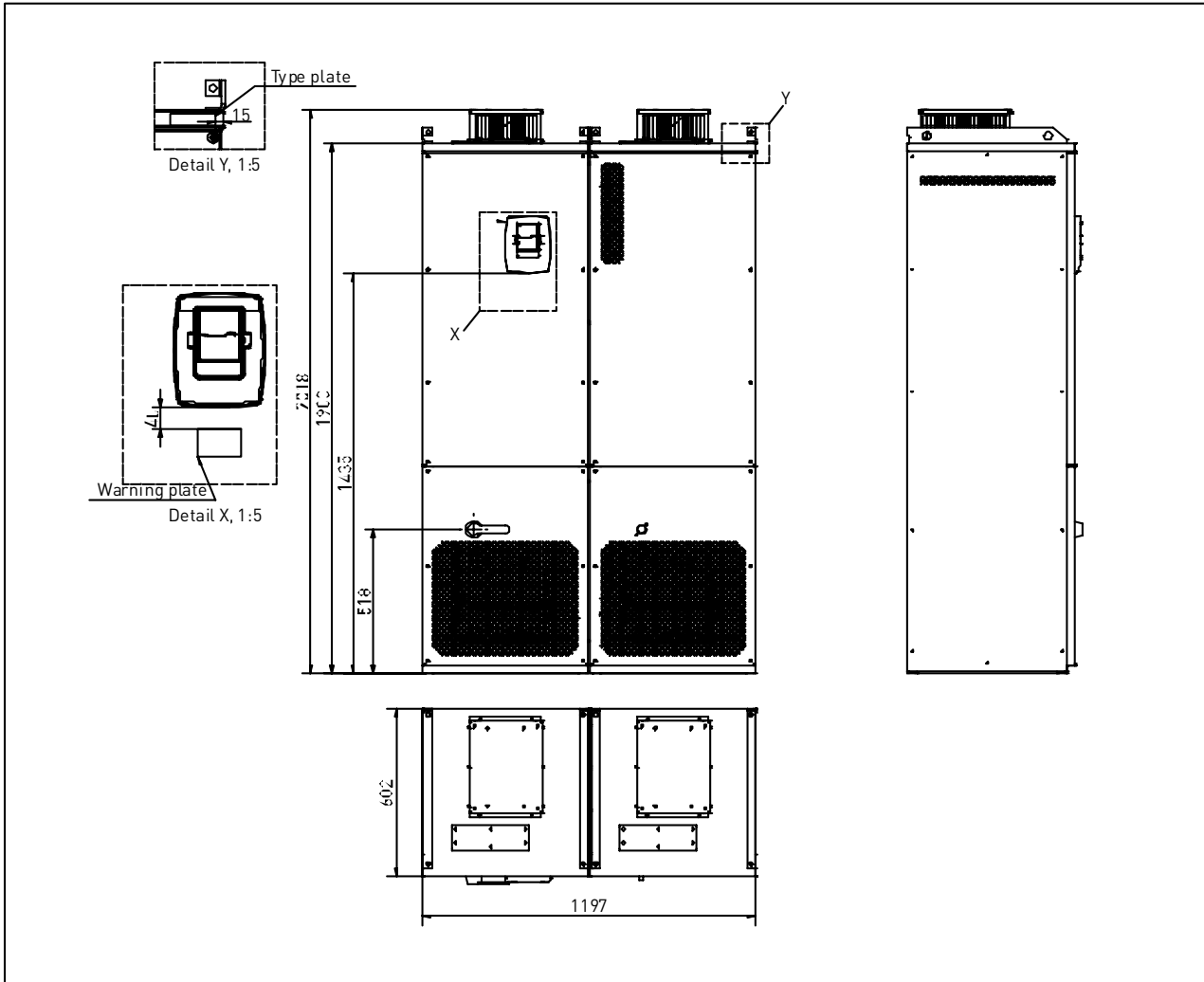

Figure 5-10. Vacon NXP dimensions, FR12 (floorstanding units)

5.2 Cooling

Enough free space shall be left around the frequency converter to ensure sufficient air circulation, cooling as well as maintenance. You will find the required dimensions for free space in the tables below.

If several units are mounted above each other the required free space equals **C + D** (see figure below). Moreover, the outlet air used for cooling by the lower unit must be directed away from the air intake of the upper unit.

The amount of cooling air required is indicated below. Also make sure that the temperature of the cooling air does not exceed the maximum ambient temperature of the converter.

5.2.1 FR4 to FR9

Type	Dimensions [mm]				
	A	A ₂	B	C	D
0004—0012 NXS2 0003—0012 NX_5	20		20	100	50
0017—0031 NXS2 0016—0031 NX_5	20		20	120	60
0048—0061 NXS2 0038—0061 NX_5 0004—0034 NX_6	30		20	160	80
0075—0114 NXS2 0072—0105 NX_5 0041—0052 NX_6	80		80	300	100
0140—0205 NXS2 0140—0205 NX_5 0062—0100 NX_6	80	150	80	300	200
0261—0300 NXS2 0261—0300 NX_5 0125—0208 NX_6	50		80	400	250 (350**)

Table 5-10. Mounting space dimensions

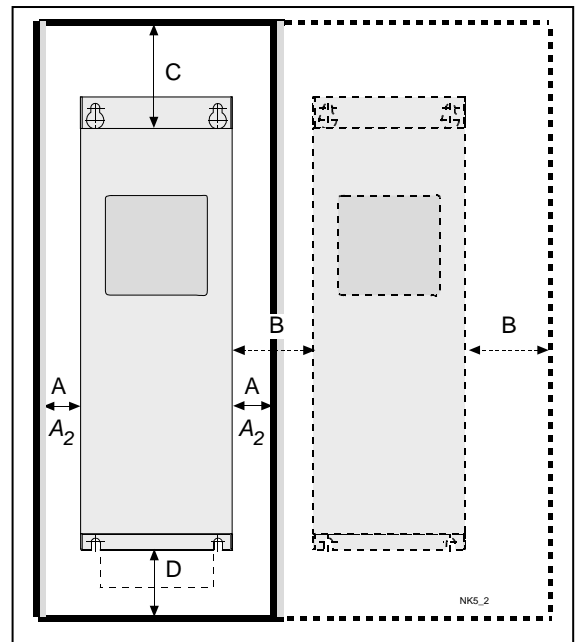

Figure 5-11. Installation space

- A** = clearance around the freq. converter (see also **A₂** and **B**)
- A₂** = clearance needed on either side of the frequency converter for fan change (without disconnecting the motor cables)
- ** = min. clearance for fan change
- B** = distance from one frequency converter to another or distance to cabinet wall
- C** = free space above the frequency converter
- D** = free space underneath the frequency converter

Type	Cooling air required [m ³ /h]
0004—0012 NXS2 0003—0012 NX_5	70
0017—0031 NXS2 0016—0031 NX_5 0004—0013 NX_6	190
0048—0061 NXS2 0038—0061 NX_5 0018—0034 NX_6	190
0075—0114 NXS2 0072—0105 NX_5 0041—0052 NX_6	425
0140—0205 NXS2 0140—0205 NX_5 0062—0100 NX_6	650
0261—0300 NXS2 0261—0300 NX_5 0125—0208 NX_6	1300

Table 5-11. Required cooling air

5.2.2 Standalone units (FR10 to FR12)

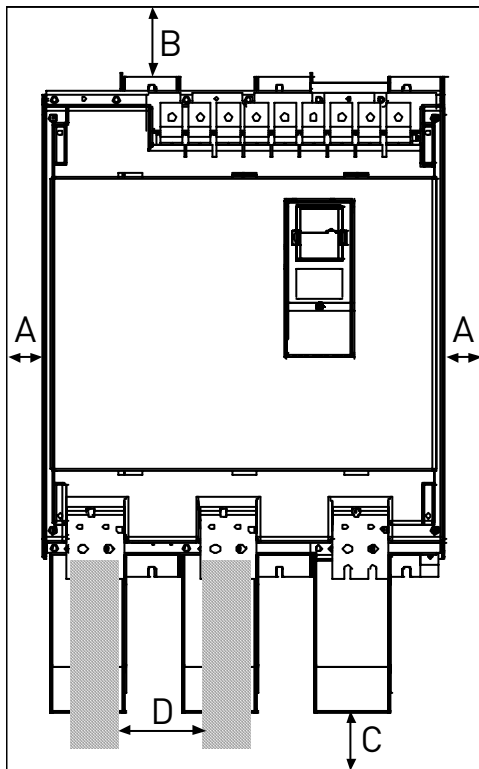

Type	Dimensions [mm]			
	A	B	C	D
0385—0520 NX_5 0261—0416 NX_6	50	100		
0590—0730 NX_5 0460—0590 NX_6	50	100	70	150
0820—1030 NX_5 0650—0820 NX_6	50	100		

- A = Minimum distance to the side walls or adjacent components.
- B = Minimum distance from the top of the cabinet
- C = Free space underneath the module
- D = Minimum distance between the phase cables

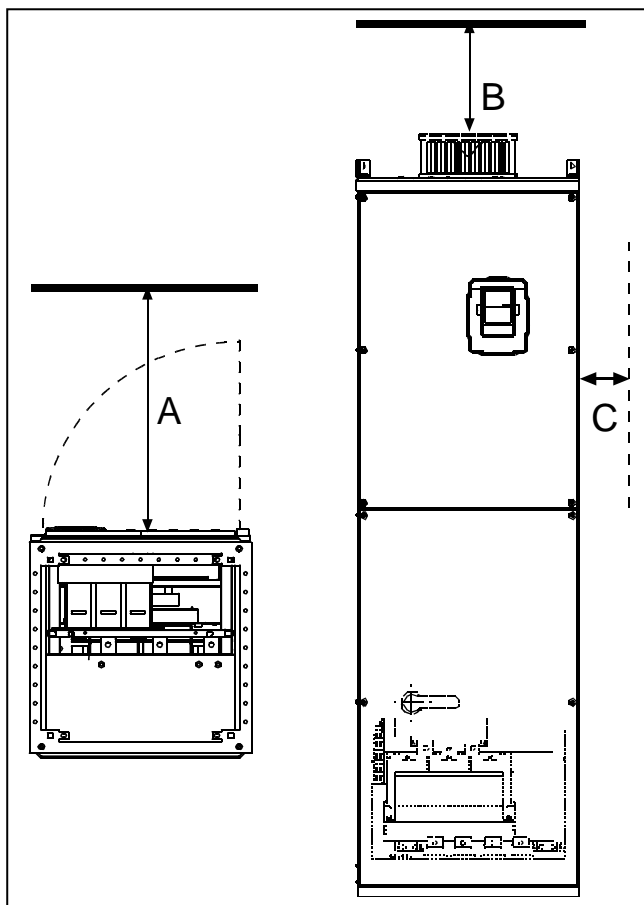

Figure 5-12. Cabinet installation space

Mounting space dimensions [mm]		
A	B	C
800	200	20

Table 5-12. Mounting space dimensions

Type	Cooling air required [m ³ /h]
0385—0520 5 0261—0416 6	2600
0650—0730 5 0460—0590 6	3900
0820—1030 5 0650—0820 6	5200

Table 5-13. Required cooling air

5.3 Power losses

5.3.1 Power losses as function of switching frequency

If the operator wants to raise the switching frequency of the drive for some reason (typically e.g. in order to reduce the motor noise), this inevitably affects the power losses and cooling requirements according to the graphs below.

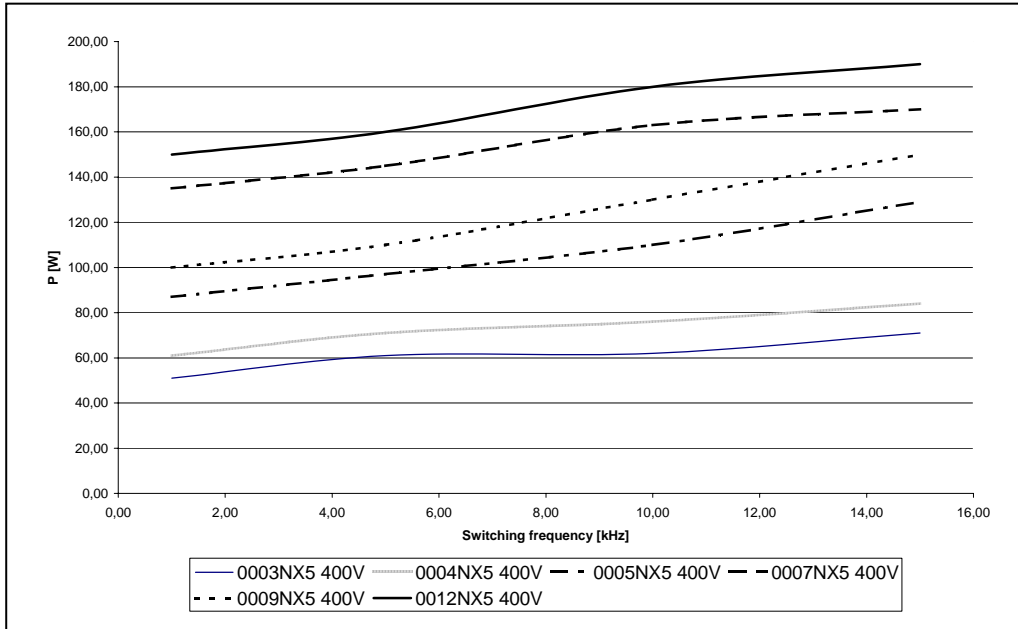

Figure 5-13. Power loss as function of switching frequency; NX_5 0003...0012

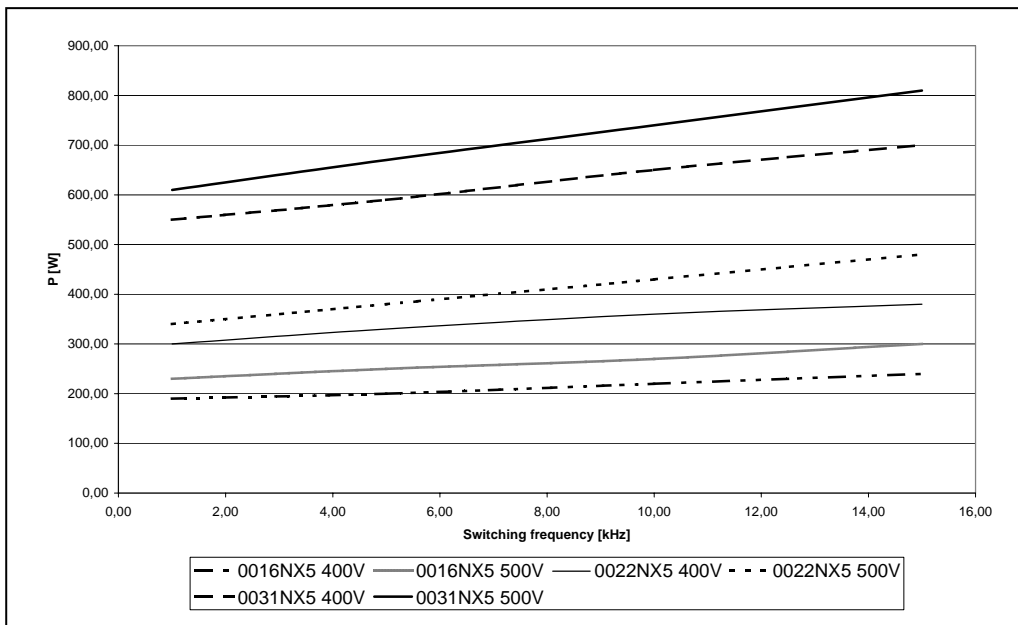

Figure 5-14. Power loss as function of switching frequency; NX_5 0016...0031

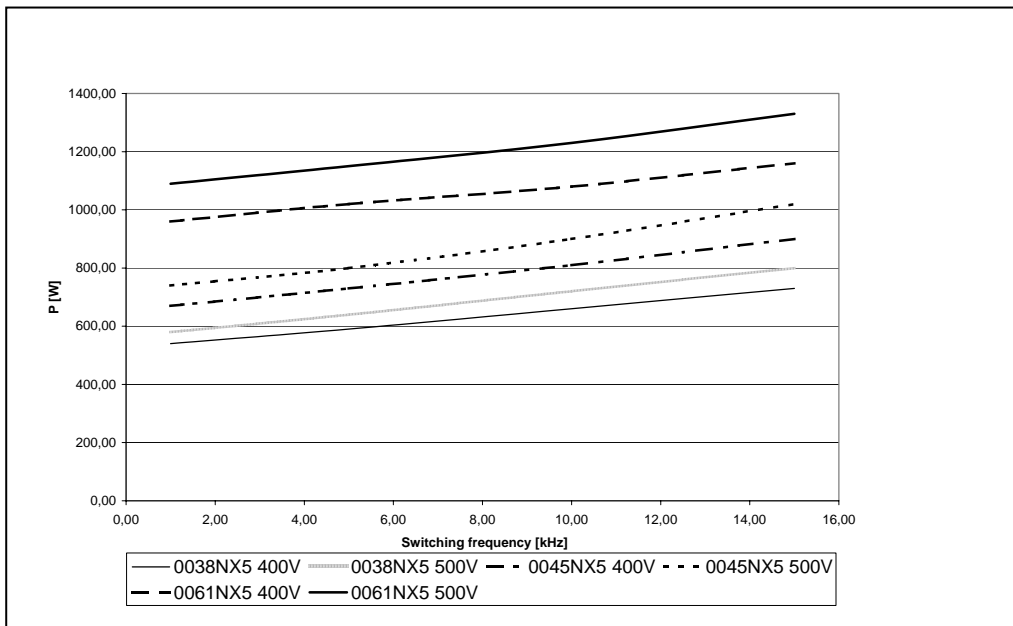

Figure 5-15. Power loss as function of switching frequency; NX_5 0038...0061

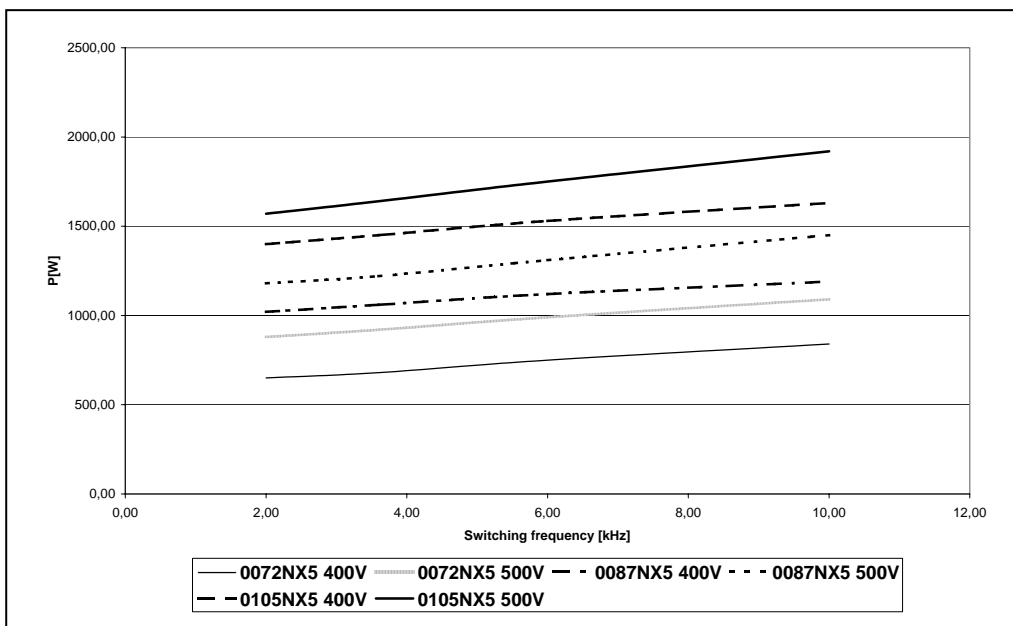

Figure 5-16. Power loss as function of switching frequency; NX_5 0072...0105

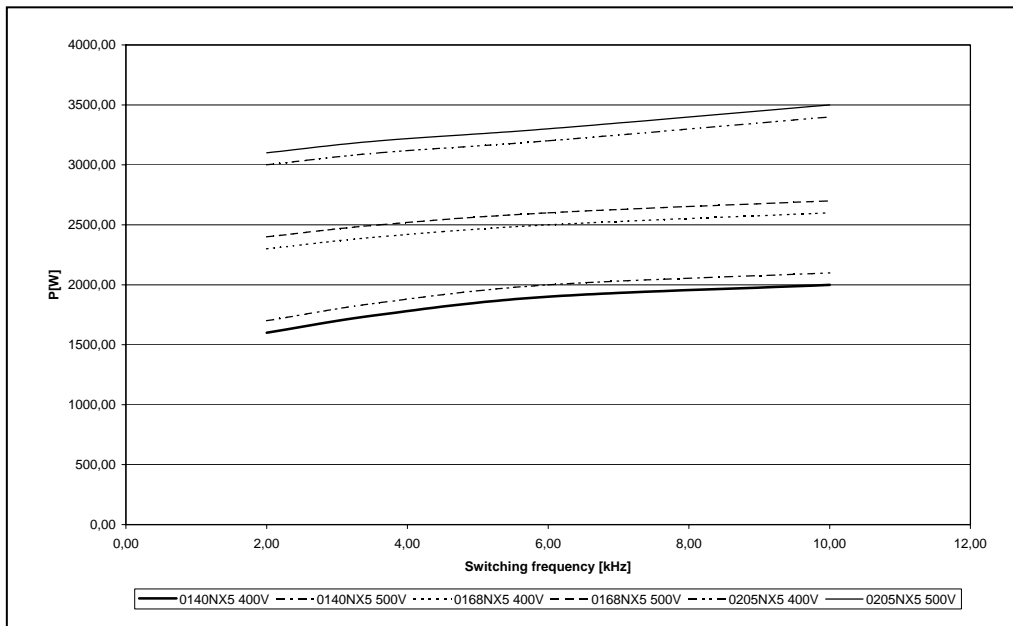

Figure 5-17. Power loss as function of switching frequency; NX_5 0140...0205

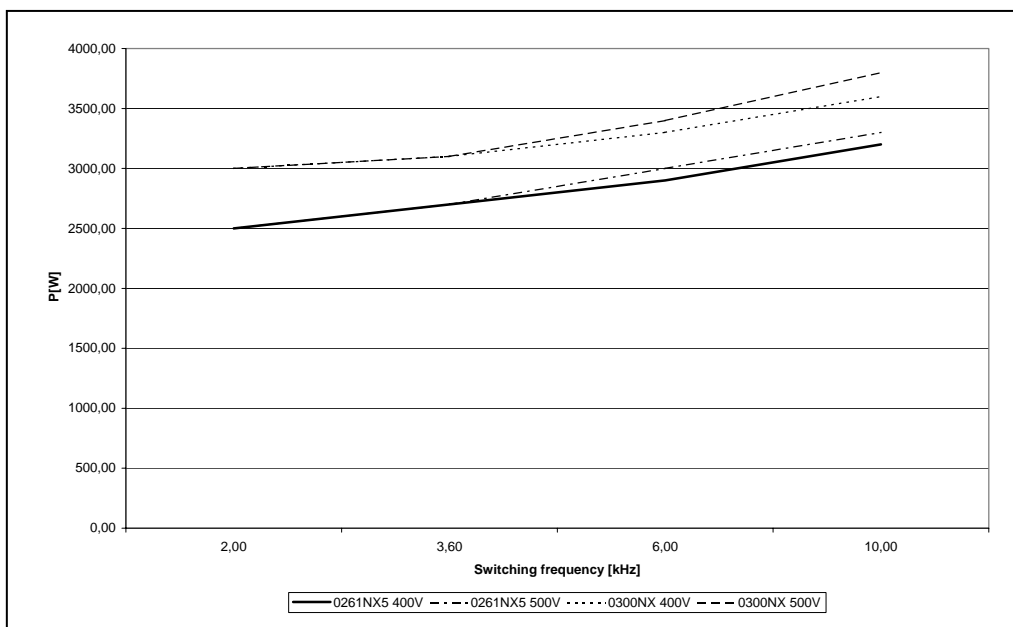

Figure 5-18. Power loss as function of switching frequency; NX_5 0261...0300

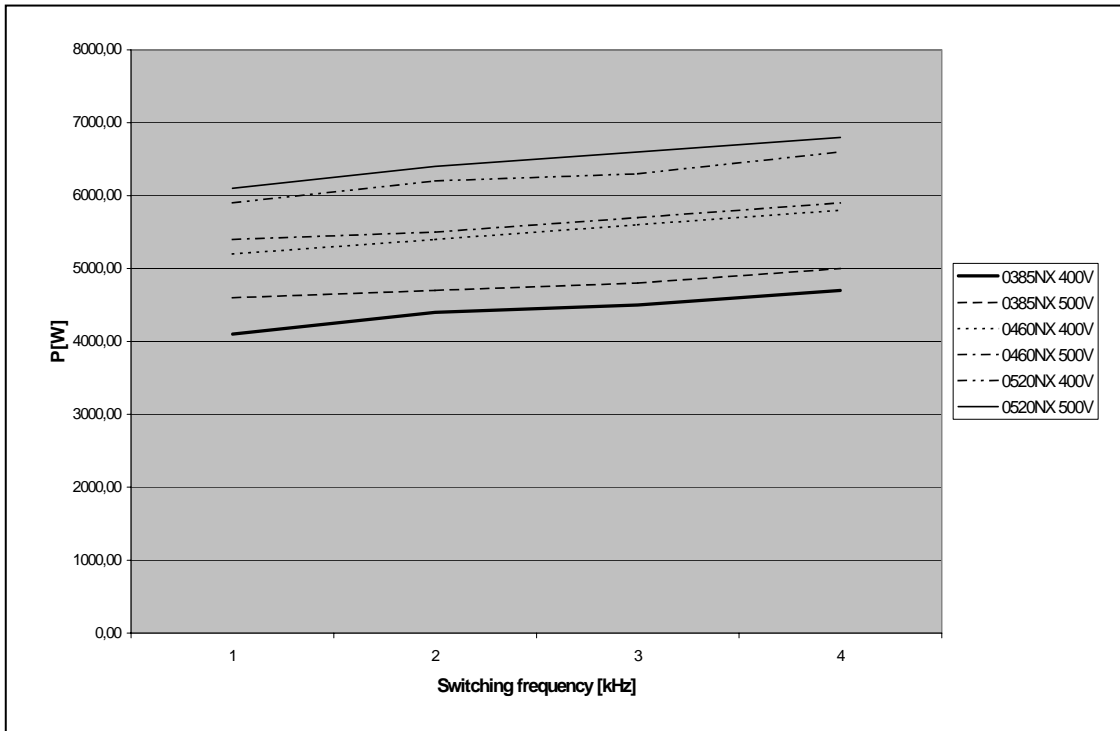

Figure 5-19. Power loss as function of switching frequency; NX_5 0385...0520

6. CABLING AND CONNECTIONS

6.1 Power unit

6.1.1 Power connections

6.1.1.1 Mains and motor cables

The mains cables are connected to terminals **L1**, **L2** and **L3** and the motor cables to terminals marked with **U**, **V** and **W**. A cable entry gland should be used when installing the motor cable at both ends in order to reach the EMC levels. See Table 6-1 for the cable recommendations for different EMC levels.

Use cables with heat resistance of at least +70°C. The cables and the fuses must be dimensioned according to the frequency converter nominal OUTPUT current which you can find on the rating plate. Dimensioning according to the output current is recommended because the frequency converter input current never significantly exceeds the output current. Installation of cables according to UL regulations is presented in Chapter 6.1.6.

Table 6-2 and Table 6-3 show the minimum dimensions of the Cu-cables and the corresponding fuse sizes. Recommended fuse types: gG/gL, see Table 6-2 and Table 6-3;

If the motor temperature protection of the drive (see Vacon All in One Application Manual) is used as an overload protection, the cable shall be chosen accordingly. If three or more cables are used in parallel for bigger units each cable requires a separate overload protection.

These instructions apply only to cases with one motor and one cable connection from the frequency converter to the motor. In any other case, ask the factory for more information.

Cable type	1 st environment		2 nd environment		Level T	Level N
	Levels C and H		Level L			
	unrestricted	restricted				
Mains cable	1		1		1	1
Motor cable	3*		2		2	2
Control cable	4		4		4	4

Table 6-1. Cable types required to meet standards.

For the definitions of EMC protection levels, see chapter 2.2.3.

- 1 = Power cable intended for fixed installation and the specific mains voltage. Shielded cable not required. (NKCABLES/MCMK or similar recommended)
- 2 = Symmetrical power cable equipped with concentric protection wire and intended for the specific mains voltage. (NKCABLES /MCMK or similar recommended).
- 3 = Symmetrical power cable equipped with compact low-impedance shield and intended for the specific mains voltage. (NKCABLES /MCCMK, SAB/ÖZCUY-J or similar recommended).
*360° earthing of the shield with cable glands in both ends needed for EMC levels C and H.
- 4 = Screened cable equipped with compact low-impedance shield (NKCABLES /JAMAK, SAB/ÖZCuY-0 or similar).

Note: The EMC requirements are fulfilled at factory defaults of switching frequencies (all frames).

6.1.1.2 DC supply and brake resistor cables

Vacon frequency converters are equipped with terminals for the DC supply and an optional external brake resistor. These terminals are marked with **B-**, **B+/R+** and **R-**. The DC bus connection is made to terminals B- and B+ and the brake resistor connection to R+ and R-. Note that the DC connection is optional for drives greater than FR8.

6.1.1.3 Control cable

For information on control cables see Chapter 6.2.1.1 and Table 6-1.

6.1.1.4 Cable and fuse sizes, NX 2 and NX 5, FR4 to FR9

The table below shows typical cable sizes and types that can be used with the converter. The final selection should be made according to local regulations, cable installation conditions and cable specification.

Frame	Type	I _L [A]	Fuse [A]	Mains and motor cable Cu [mm ²]	Terminal cable size	
					Main terminal [mm ²]	Earth terminal [mm ²]
FR4	NX0004 2—0008 2 NX0003 5—0009 5	3—8 3—9	10	3*1.5+1.5	1—4	1—4
	NX0011 2—0012 2 NX0012 5	11—12 12	16	3*2.5+2.5	1—4	1—4
FR5	NX0017 2 NX0016 5	17 16	20	3*4+4	1—10	1—10
	NX0025 2 NX0022 5	25 22	25	3*6+6	1—10	1—10
	NX0031 2 NX0031 5	32 31	35	3*10+10	1—10	1—10
	NX0048 2 NX0038 5—0045 5	48 38—45	50	3*10+10	2.5—50 Cu 6—50 Al	2.5—35
FR6	NX0061 2 NX0061 5	61	63	3*16+16	2.5—50 Cu 6—50 Al	2.5—35
	NX0075 2 NX0072 5	75 72	80	3*25+16	2.5—50 Cu 6—50 Al	6—70
FR7	NX0088 2 NX0087 5	88 87	100	3*35+16	2.5—50 Cu 6—50 Al	6—70
	NX0114 2 NX0105 5	114 105	125	3*50+25	2.5—50 Cu 6—50 Al	6—70
	NX0140 2 NX0140 5	140	160	3*70+35	25—95 Cu/Al	25—95
FR8	NX0170 2 NX0168 5	168	200	3*95+50	95—185 Cu/Al	25—95
	NX0205 2 NX0205 5	205	250	3*150+70	95—185 Cu/Al	25—95
	NX0261 2 NX0261 5	261	315	3*185+95 or 2*(3*120+70)	95—185 Cu/Al 2	5—95
FR9	NX0300 2 NX0300 5	300	315	2*(3*120+70)	95—185 Cu/Al 2	5—95

Table 6-2. Cable and fuse sizes for Vacon NXS2 and NX_5 (FR4 to FR9)

See chapter 1.3.

6.1.1.5 Cable and fuse sizes, NX 6, FR6 to FR9

The table below shows typical cable sizes and types that can be used with the converter. The final selection should be made according to local regulations, cable installation conditions and cable specification.

Frame	Type	I _L [A]	Fuse [A]	Mains and motor cable Cu [mm ²]	Terminal cable size	
					Main terminal [mm ²]	Earth terminal [mm ²]
FR6	NX0004 6—0007 6	3—7	10	3*2.5+2.5	2.5—50 Cu 6—50 Al	2.5—35
	NX0010 6—0013 6	10-13	16	3*2.5+2.5	2.5—50 Cu 6—50 Al	2.5—35
	NX0018 6	18	20	3*4+4	2.5—50 Cu 6—50 Al	2.5—35
	NX0022 6	22	25	3*6+6	2.5—50 Cu 6—50 Al	2.5—35
	NX0027 6—0034 6	27-34	35	3*10+10	2.5—50 Cu 6—50 Al	2.5—35
FR7	NX0041 6	41	50	3*10+10	2.5—50 Cu 6—50 Al	6—50
	NX0052 6	52	63	3*16+16	2.5—50 Cu 6—50 Al	6—50
FR8	NX0062—0080 6	62—80	80	3*25+16	25—95 Cu/Al	25—95
	NX0100 6	100	100	3*35+16		
FR9	NX0125—NX0144 6	125-144	160	3*95+50	95-185 Cu/Al2	5—95
	NX0170 6	170	200			
	NX0208 6	208	250			

Table 6-3. Cable and fuse sizes for Vacon NX_6 (FR6 to FR9)

¹⁾based on correction factor 0.7

See chapter 1.3.

6.1.1.6 Cable and fuse sizes, NX 5, FR10 to FR12

The table below shows typical cable sizes and types that can be used with the converter. The final selection should be made according to local regulations, cable installation conditions and cable specification.

Frame	Type	I _L [A]	Fuse I _n [A]	Mains and motor cable ¹⁾ [mm ²]	No. of supply cables	No. of motor cables
FR10	NX0385 5	385	400 (3 pcs)	Cu: 2*(3*120+70) Al: 2*(3*185Al+57Cu)	Even/Odd	Even/Odd
	NX0460 5	460	500 (3 pcs)	Cu: 2*(3*150+70) Al: 2*(3*240Al+72Cu)	Even/Odd	Even/Odd
	NX0520 5	520	630 (3 pcs)	Cu: 2*(3*185+95) Al: 2*(3*300Al+88Cu)	Even/Odd	Even/Odd
FR11	NX0590 5	590	315 (6 pcs)	Cu: 2*(3*240+120) Al: 4*(3*120Al+41Cu)	Even	Even/Odd
	NX0650 5	650	400 (6 pcs)	Cu: 4*(3*95+50) Al: 4*(3*150Al+41Cu)	Even	Even/Odd
	NX0730 5	730	400 (6 pcs)	Cu: 4*(3*120+70) Al: 4*(3*185Al+57Cu)	Even	Even/Odd
FR12	NX0820 5	820	500 (6 pcs)	Cu: 4*(3*150+70) Al: 4*(3*185Al+57Cu)	Even	Even
	NX0920 5	920	500 (6 pcs)	Cu: 4*(3*150+70) Al: 4*(3*240Al+72Cu)	Even	Even
	NX1030 5	1030	630 (6 pcs)	Cu: 4*(3*185+95) Al: 4*(3*300Al+88Cu)	Even	Even

Table 6-4. Cable and fuse sizes for Vacon NX_5 (FR10 to FR12)

¹⁾based on correction factor 0.7

6.1.1.7 Cable and fuse sizes, NX 6, FR10 to FR12

The table below shows typical cable sizes and types that can be used with the converter. The final selection should be made according to local regulations, cable installation conditions and cable specification.

Frame	Type	I _L [A]	Fuse I _n [A]	Mains and motor cable ¹⁾ [mm ²]	No of supply cables	No of motor cables
FR10	NX0261 6	261	315 (3 pcs)	Cu: 3*185+95 Al: 2*(3*95Al+29Cu)	Even/Odd	Even/Odd
	NX0325 6	325	400 (3 pcs)	Cu: 2*(3*95+50) Al: 2*(3*150Al+41Cu)	Even/Odd	Even/Odd
	NX0385 6	385	400 (3 pcs)	Cu: 2*(3*120+70) Al: 2*(3*185Al+57Cu)	Even/Odd	Even/Odd
	NX0416 6	416	500 (3 pcs)	Cu: 2*(3*150+70) Al: 2*(3*185Al+57Cu)	Even/Odd	Even/Odd
FR11	NX0460 6	460	500 (3 pcs)	Cu: 2*(3*150+70) Al: 2*(3*240Al+72Cu)	Even/Odd	Even/Odd
	NX0502 6	502	630 (3 pcs)	Cu: 2*(3*185+95) Al: 2*(3*300Al+88 Cu)	Even/Odd	Even/Odd
	NX0590 6	590	315 (6 pcs)	Cu: 2*(3*240+120) Al: 4*(3*120Al+41Cu)	Even	Even/Odd
FR12	NX0650 6	650	400 (6 pcs)	Cu: 4*(3*95+50) Al: 4*(3*150Al+41Cu)	Even	Even
	NX0750 6	750	400 (6 pcs)	Cu: 4*(3*120+70) Al: 4*(3*150Al+41Cu)	Even	Even
	NX0820 6	820	500 (6 pcs)	Cu: 4*(3*150+70) Al: 4*(3*185Al+57Cu)	Even	Even

Table 6-5. Cable and fuse sizes for Vacon NX_6 (FR10 to FR12)

¹⁾based on correction factor 0.7

6.1.2 Understanding the power unit topology

Figure 6-1 shows the principles for mains and motor connections of the basic 6-pulse drive in frame sizes FR4 to FR12.

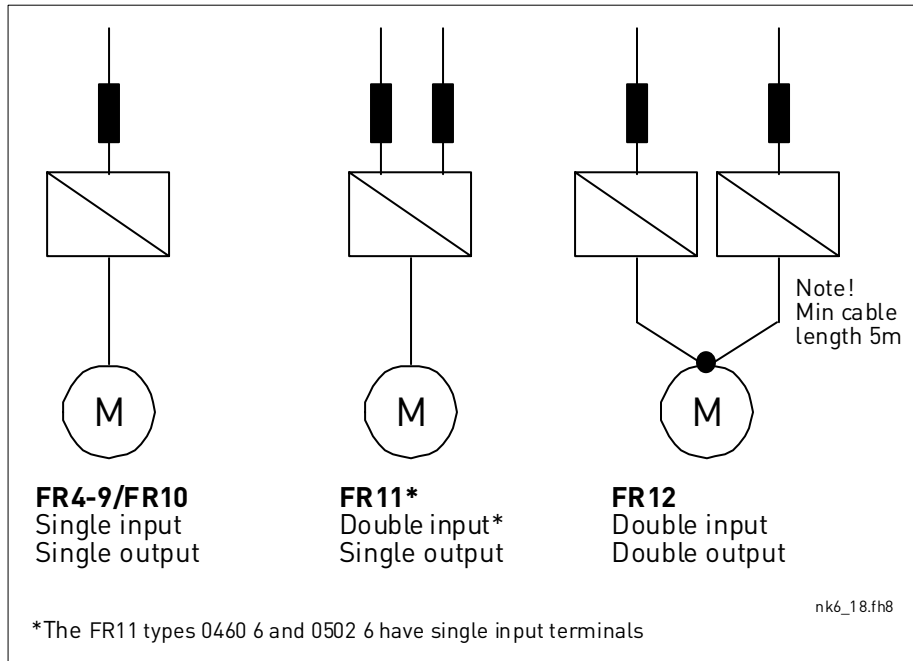

Figure 6-1. Topology of mechanical sizes FR4 – FR12

6.1.3 Changing the EMC protection class

The EMC protection level of Vacon NX_ frequency converters can be changed from class H to class T (and from class L to T in NX_6 FR6) with a simple procedure presented in the following figures.

Note! After having performed the change check *EMC Level modified* on the sticker included in the NX delivery (see below) and note the date. Unless already done, attach the sticker close to the nameplate of the frequency converter.

Drive modified:		
<input type="checkbox"/>	Option board: NXOPT.....	Date:.....
	in slot: A B C D E	
<input type="checkbox"/>	IP54 upgrade/ Collar	Date:.....
<input type="checkbox"/>	EMC level modified: H/ L to T	Date:.....

FR4 and FR5:

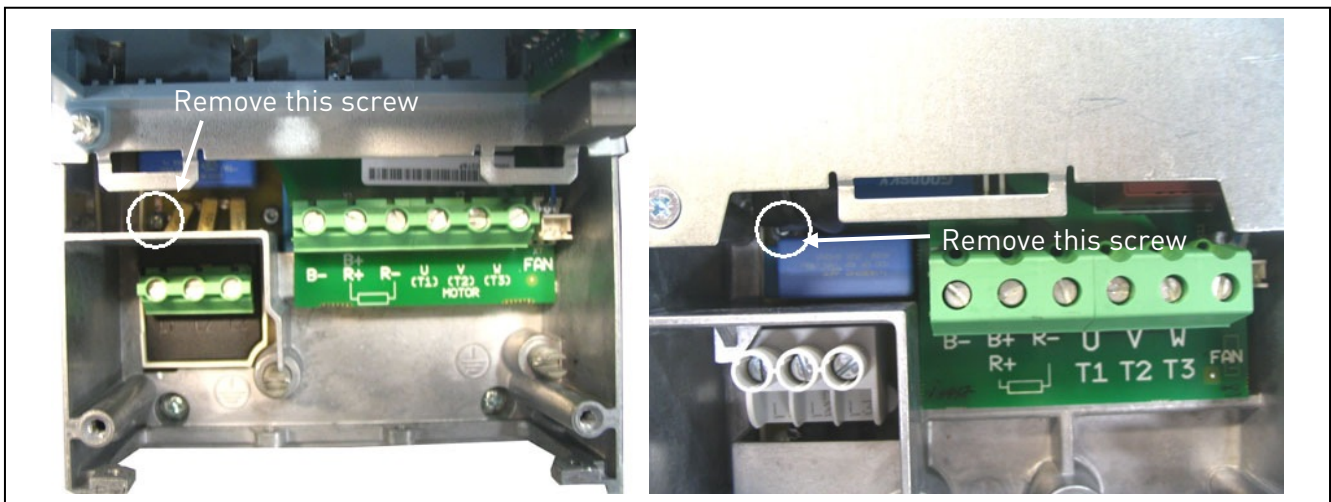

Figure 6-2. Changing of EMC protection class, FR4 (left) and FR5 (right). First remove the cable cover.

FR6:



Figure 6-3. Changing of EMC protection class, FR6. The cable cover does not need to be removed

FR7:

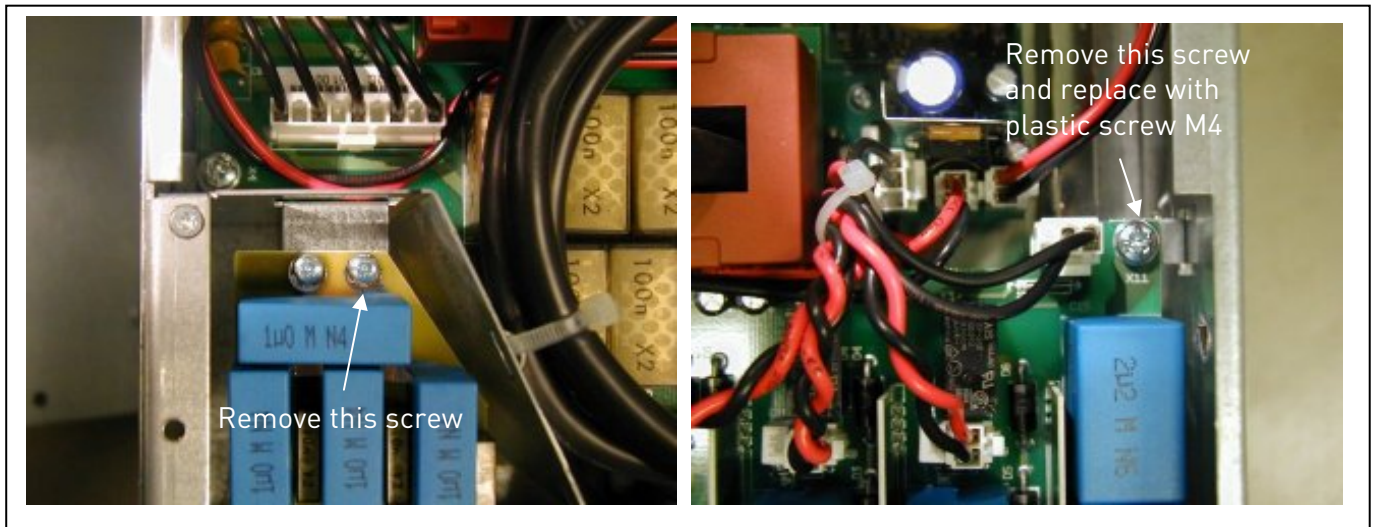

Figure 6-4. Changing of EMC protection class, FR7

NOTE! Only a Vacon service person may change the EMC protection class of Vacon NXS/P, FR8 and FR9.

6.1.4 Mounting of cable accessories

Enclosed to your Vacon NXS/P frequency converter you have received a plastic bag containing components that are needed for the installation of the mains and motor cables in the frequency converter.

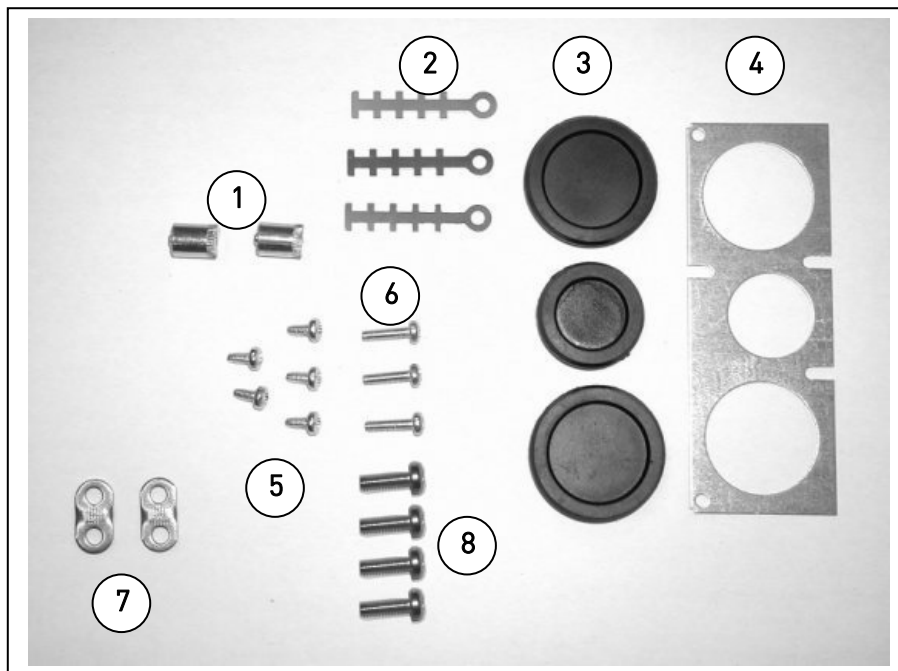

Figure 6-5. Cable accessories

Components:

- | | |
|---|--|
| 1 | Grounding terminals (FR4, FR5/MF4, MF5) [2] |
| 2 | Cable clamps [3] |
| 3 | Rubber grommets (sizes vary from class to class) [3] |
| 4 | Cable entry gland [1] |
| 5 | Screws, M4x10 [5] |
| 6 | Screws, M4x16 [3] |
| 7 | Grounding cable clamps (FR6, MF6) [2] |
| 8 | Grounding screws M5x16 (FR6, MF6) [4] |

NOTE: The cable accessories installation kit for frequency converters of protection class **IP54** includes all components except **4** and **5**.

Mounting procedure

1. Make sure that the plastic bag you have received contains all necessary components.
2. Open the cover of the frequency converter (**Figure 1**).
3. Remove the cable cover. Observe the places for
 - a) the grounding terminals (FR4/FR5; MF4/MF6) (**Figure 2**).
 - b) the grounding cable clamps (FR6/MF6) (**Figure 3**).
4. Re-install the cable cover. Mount the cable clamps with the three M4x16 screws as shown in **Figure 4**. Note that the location of the grounding bar in FR6/MF6 is different from what is shown in the picture.
5. Place the rubber grommets in the openings as shown in **Figure 5**.
6. Fix the cable entry gland to the frame of the frequency converter with the five M4x10 screws (**Figure 6**). Close the cover of the frequency converter.

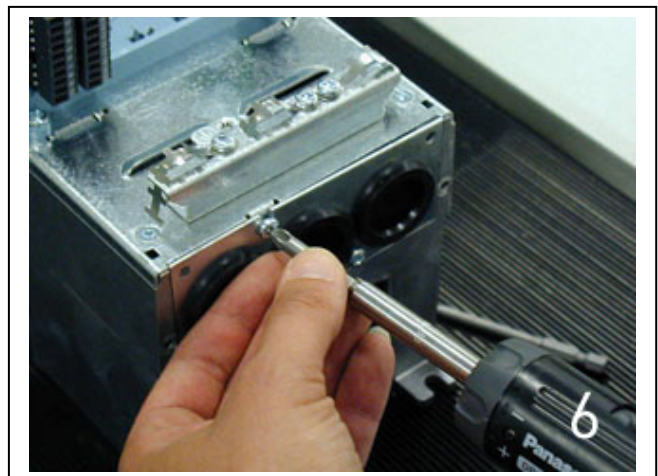
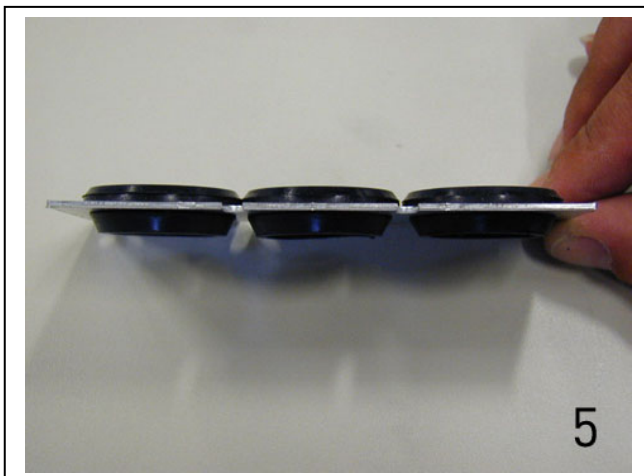
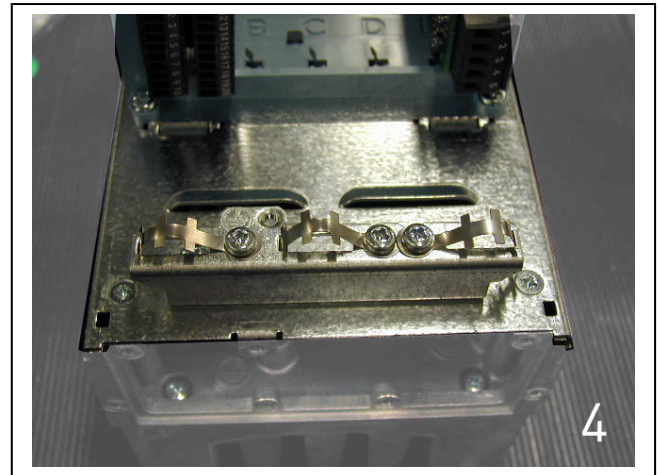
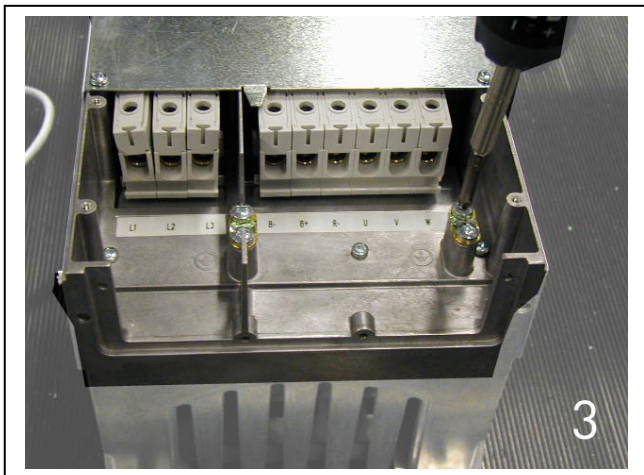
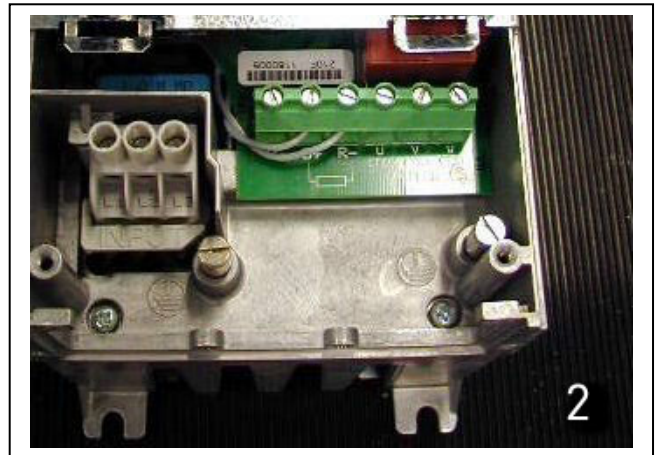
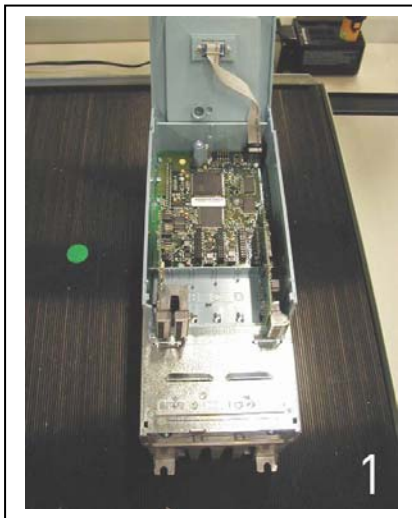

6.1.5 Installation instructions

1	Before starting the installation, check that none of the components of the frequency converter is live.						
2	<p>Place the motor cables sufficiently far from other cables:</p> <ul style="list-style-type: none"> ▪ Avoid placing the motor cables in long parallel lines with other cables ▪ If the motor cables runs in parallel with other cables, note the minimum distances between the motor cables and other cables given in table below. ▪ The given distances also apply between the motor cables and signal cables of other systems. ▪ The maximum length of the motor cables is 300 m (units with power greater than 1.5 kW) and 100 m (units with power from 0.75 to 1.5 kW). ▪ NOTE: If you use long motor cables (max. 100m) together with small drives (≤ 1.5 kW) the motor current measured by the drive can be much higher than the actual motor current due to capacitive currents in the motor cable. Consider this when setting up the motor stall protection functions. ▪ The motor cables should cross other cables at an angle of 90 degrees. <table border="1" style="margin-left: auto; margin-right: auto;"> <thead> <tr> <th style="text-align: center;">Distance between cables [m]</th> <th style="text-align: center;">Shielded cable [m]</th> </tr> </thead> <tbody> <tr> <td style="text-align: center;">0.3</td> <td style="text-align: center;">≤ 50</td> </tr> <tr> <td style="text-align: center;">1.0</td> <td style="text-align: center;">≤ 200</td> </tr> </tbody> </table>	Distance between cables [m]	Shielded cable [m]	0.3	≤ 50	1.0	≤ 200
Distance between cables [m]	Shielded cable [m]						
0.3	≤ 50						
1.0	≤ 200						
3	If cable insulation checks are needed, see Chapter 6.1.7.						
4	<p>Connect the cables:</p> <ul style="list-style-type: none"> ▪ Strip the motor and mains cables as advised in Table 6-6 and Figure 6-6. ▪ Remove the screws of the cable protection plate. Do not open the cover of the power unit! ▪ Make holes into and pass the cables through the rubber grommets on the bottom of the power unit (see chapter 6.1.4). Note: Use a cable gland instead of the grommet in types where this is required. ▪ Connect the mains, motor and control cables into their respective terminals (see e.g. Figure 6-11). ▪ For information on the installation of greater units, please contact the factory or your local distributor. ▪ For Information on cable installation according to UL regulations see Chapter 6.1.6. ▪ Make sure that the control cable wires do not come in contact with the electronic components of the unit. ▪ If an external brake resistor (option) is used, connect its cable to the appropriate terminal. ▪ Check the connection of the earth cable to the motor and the frequency converter terminals marked with \oplus. ▪ Connect the separate shield of the power cable to the earth terminals of the frequency converter, motor and the supply centre. ▪ Attach the cable protection plate with the screws. ▪ Ensure that the control cables or the cables of the unit are not trapped between the frame and the protection plate. 						

6.1.5.1 *Stripping lengths of motor and mains cables*

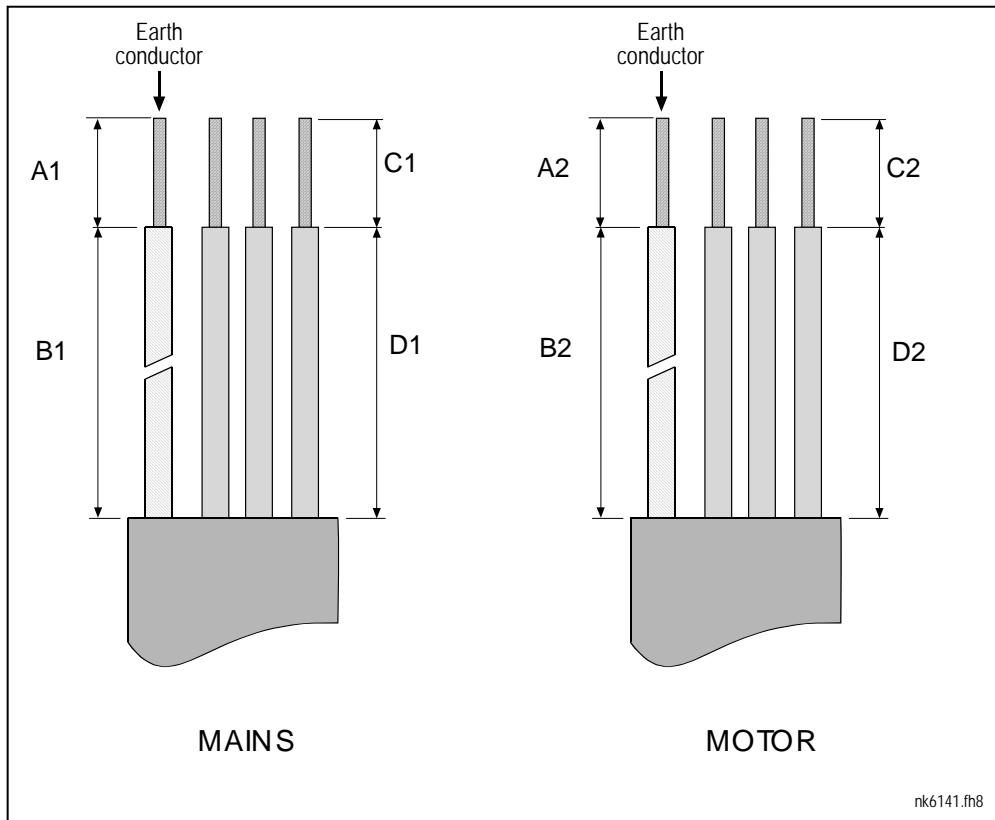

Figure 6-6. Stripping of cables

Frame	A1	B1	C1	D1	A2	B2	C2	D2
FR4	15	35	10	20	7	50	7	35
FR5	20	40	10	30	20	60	10	40
FR6	20	90	15	60	20	90	15	60
FR7	25	120	25	120	25	120	25	120
FR8								
0140	23	240	23	240	23	240	23	240
0168–0205	28	240	28	240	28	240	28	240
FR9	28	295	28	295	28	295	28	295

Table 6-6. Cables stripping lengths [mm]

6.1.5.2 *Vacon NX frames and installation of cables*

Note: In case you want to connect an external brake resistor, see separate Brake Resistor Manual. See also Chapter 'Internal brake resistor connection (P6.7.1)' on page 100 in this manual.

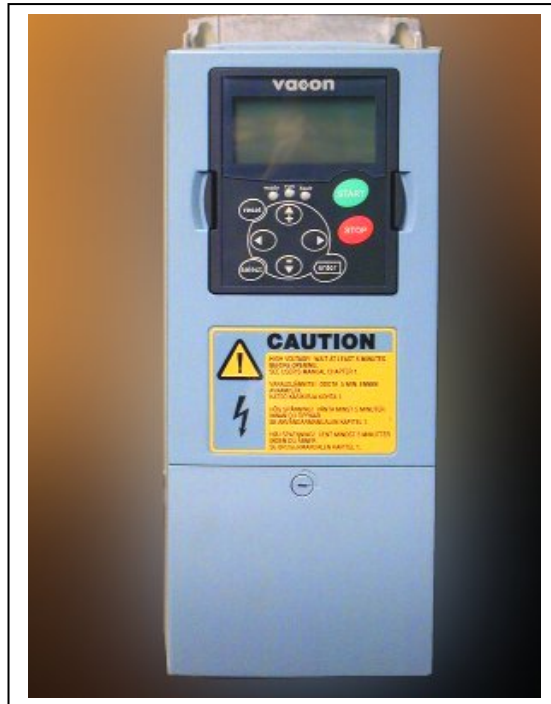

Figure 6-7. Vacon NXS/P, FR4

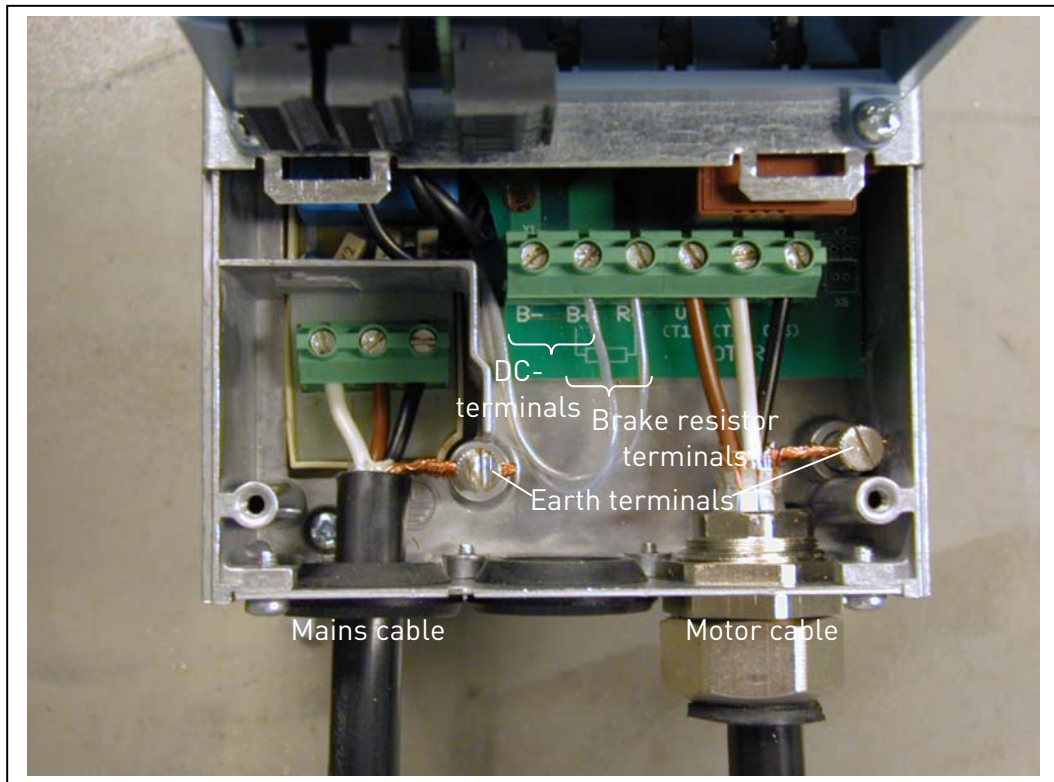

Figure 6-8. Cable installation in Vacon NXS/P, FR4

NOTE: Two protective conductors are required for FR4 according to standard EN61800-5-1. See page 56 and chapter 1.3.

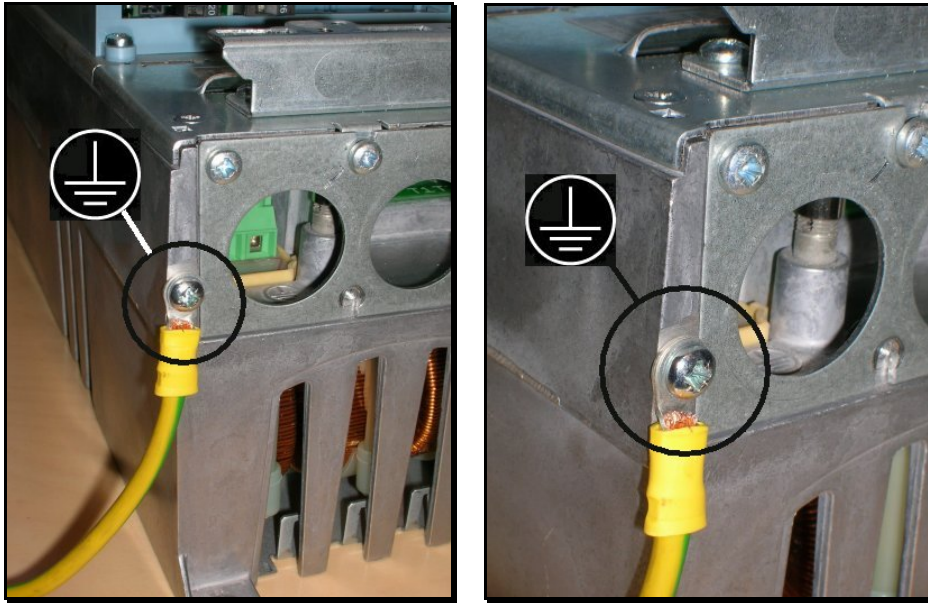

Figure 6-9. Additional grounding connector for FR4



Figure 6-10. Vacon NXS/P, FR5.

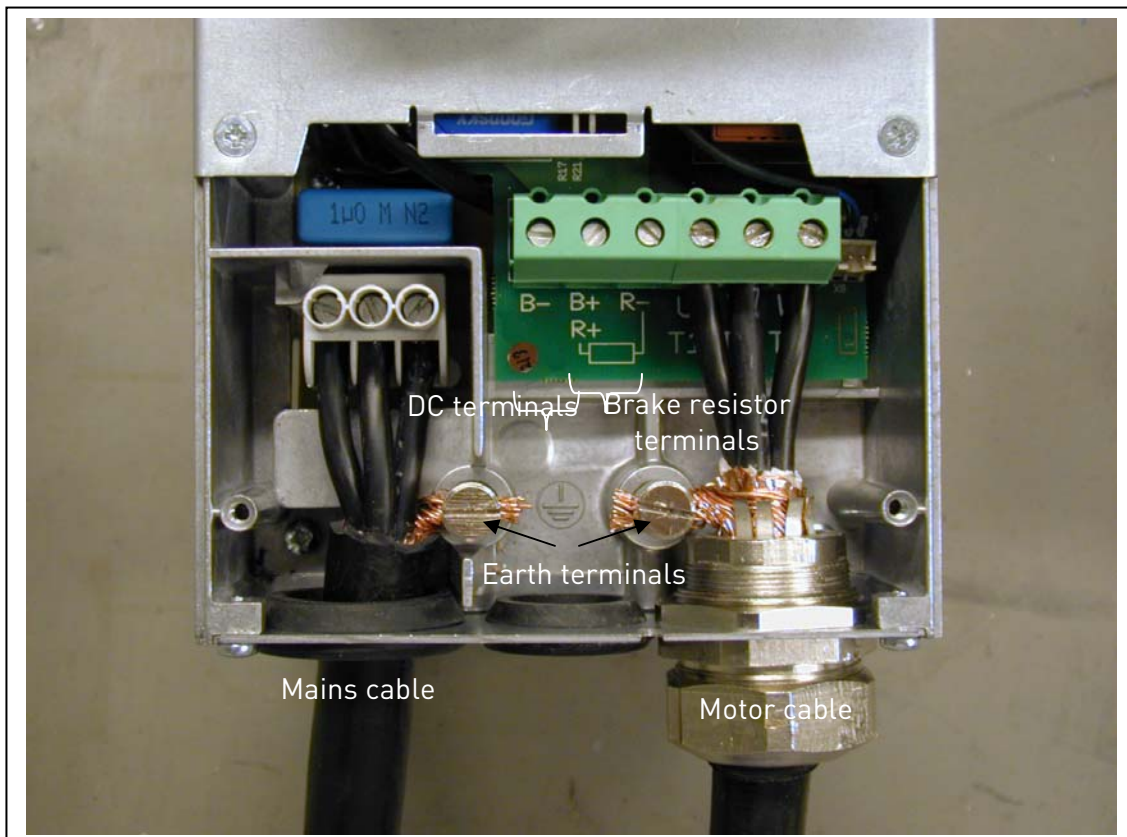

Figure 6-11. Cable installation in Vacon NXS/P, FR5

NOTE: See chapter 1.3.



Figure 6-12. Vacon NXS/P, FR6.

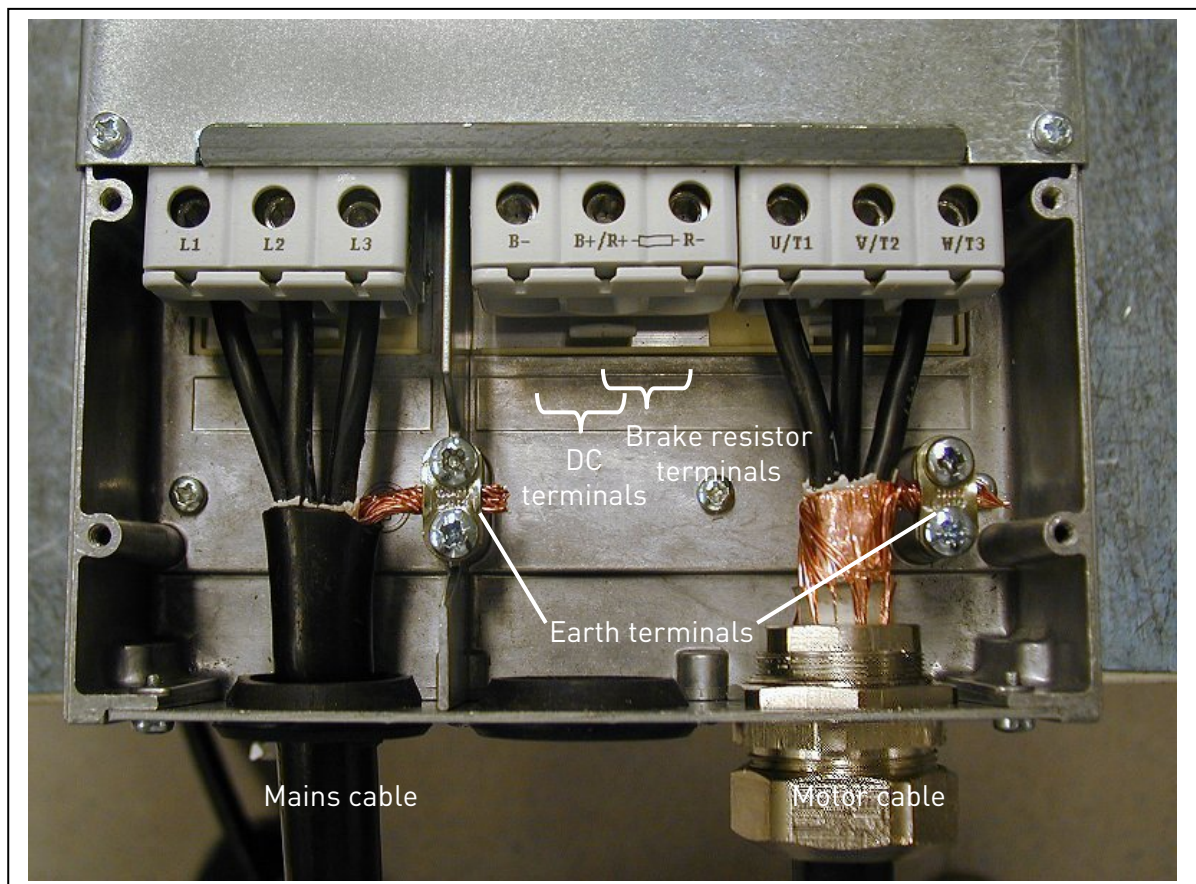

Figure 6-13. Cable installation in Vacon NXS/P, FR6

NOTE: See chapter 1.3.



Figure 6-14. Vacon NXS/P, FR7.

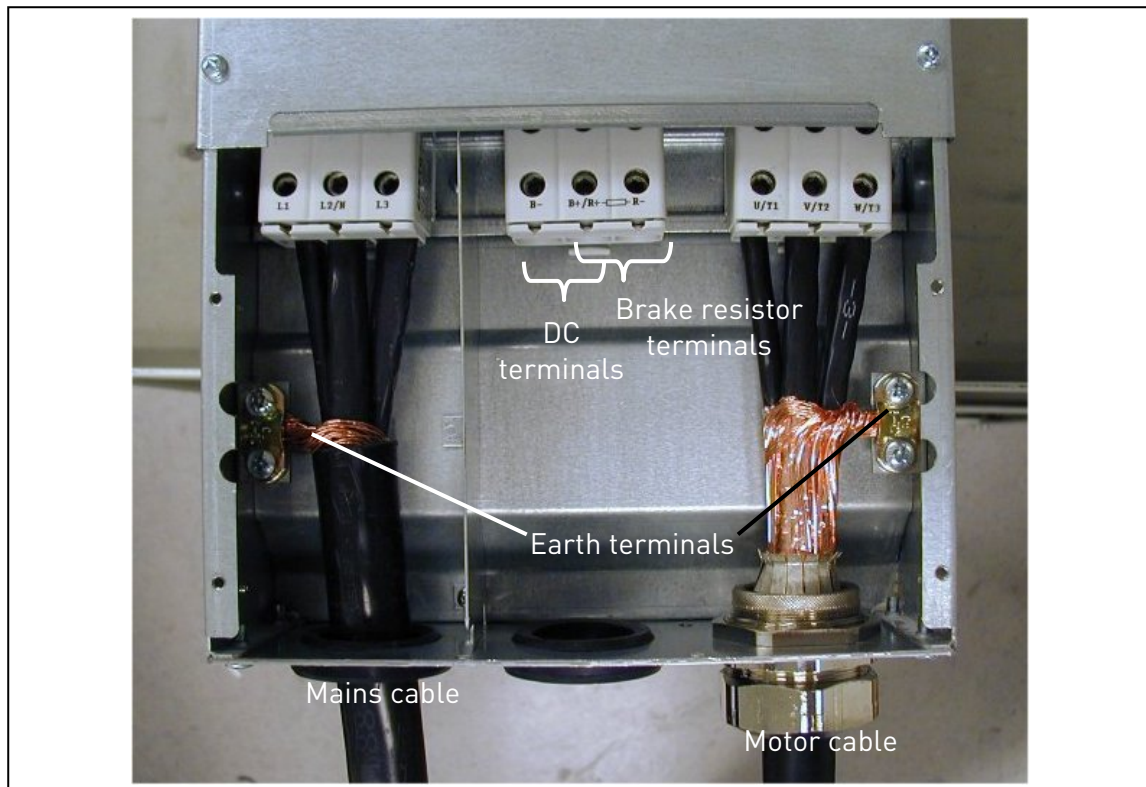

Figure 6-15. Cable installation in Vacon NXS/P, FR7

NOTE: See chapter 1.3.



Figure 6-16. Vacon NXS/P, FR8 (with optional DC/brake resistor connection box on top)



Figure 6-17. Cable installation in Vacon NXS/P, FR8

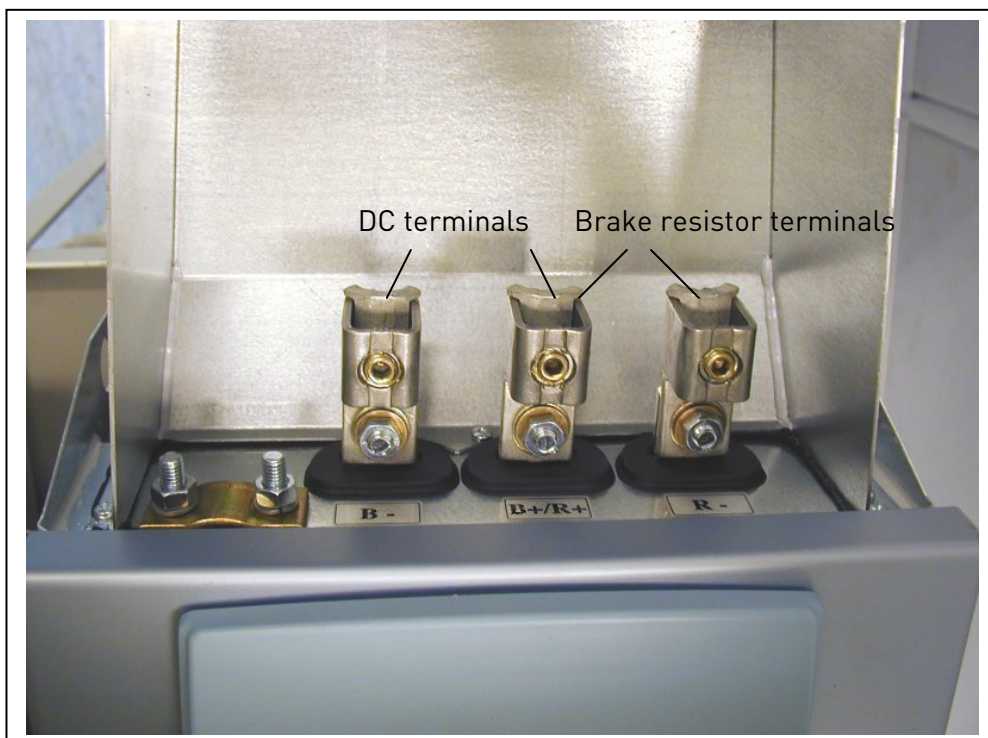

Figure 6-18. Brake resistor terminal box on top of FR8



Figure 6-19. Vacon NXS/P, FR9



Figure 6-20. Cable installation in Vacon NXS/P, FR9



Figure 6-21. DC and brake resistor terminals on FR9; DC terminals marked with B- and B+, brake resistor terminals marked with R+ and R-



Figure 6-22. Example of NXS/P standalone drives (FR11)

Note: More information on cabling for frames FR10 and greater you will find in Vacon NXP/C User's Manual.

6.1.6 Cable selection and unit installation in accordance with the UL standards

To meet the UL ([Underwriters Laboratories](#)) regulations, use a UL-approved copper cable with a minimum heat-resistance of +60/75°C. Use Class 1 wire only.

The units are suitable for use on a circuit capable of delivering not more than 100,000 rms symmetrical amperes, 600V maximum.

The tightening torques of the terminals are given in Table 6-7.

Type	Frame	Tightening torque [Nm]
NXS2 0004—0012 NX_5 0003—0012	FR4	0.5—0.6
NXS2 0017—0031 NX_5 0016—0031	FR5	1.2—1.5
NXS2 0048—0061 NX_5 0038—0061 NX_6 0004—0034	FR6	10
NXS2 0075—0114 NX_5 0072—0105 NX_6 0041—0080	FR7	10
NXS2 0140 NX_5 0140	FR8	20/9*
NXS2 0168—0205 NX_5 0168—0205	FR8	40/22*
NXS2 0261—0300 NX_5 0261—0300 NX_6 0125—0208	FR9	40/22*
NX_5 0385—1030	FR10...12	40*
NX_6 0261—820	FR10...12	40*

* Tightening torque of terminal connection to the isolative base in Nm/in-lbs.
** Apply counter torque to the nut on the other side of the terminal when tightening/loosening the terminal screw in order to avoid damage to the terminal.

Table 6-7. Tightening torques of terminals

6.1.7 Cable and motor insulation checks

1. Motor cable insulation checks

Disconnect the motor cable from terminals U, V and W of the frequency converter and from the motor. Measure the insulation resistance of the motor cable between each phase conductor as well as between each phase conductor and the protective ground conductor. The insulation resistance must be >1MΩ.

2. Mains cable insulation checks

Disconnect the mains cable from terminals L1, L2 and L3 of the frequency converter and from the mains. Measure the insulation resistance of the mains cable between each phase conductor as well as between each phase conductor and the protective ground conductor. The insulation resistance must be >1MΩ.

3. Motor insulation checks

Disconnect the motor cable from the motor and open the bridging connections in the motor connection box. Measure the insulation resistance of each motor winding. The measurement voltage must equal at least the motor nominal voltage but not exceed 1000 V. The insulation resistance must be >1MΩ.

6.2 Control unit

The control unit of the frequency converter consists roughly of the control board and additional boards (see Figure 6-23 and Figure 6-24) connected to the five *slot connectors* (A to E) of the control board. The control board is connected to the power unit through a D-connector (1) or fibre optic cables (FR9).

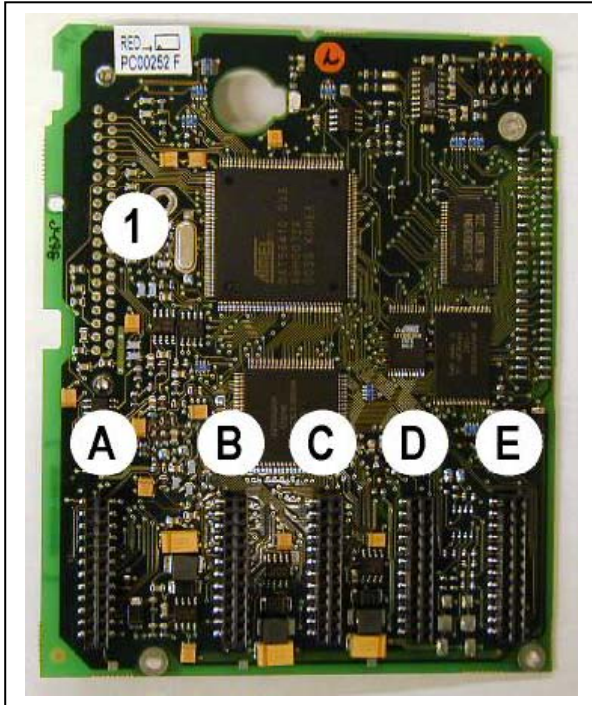

Figure 6-23. NX control board

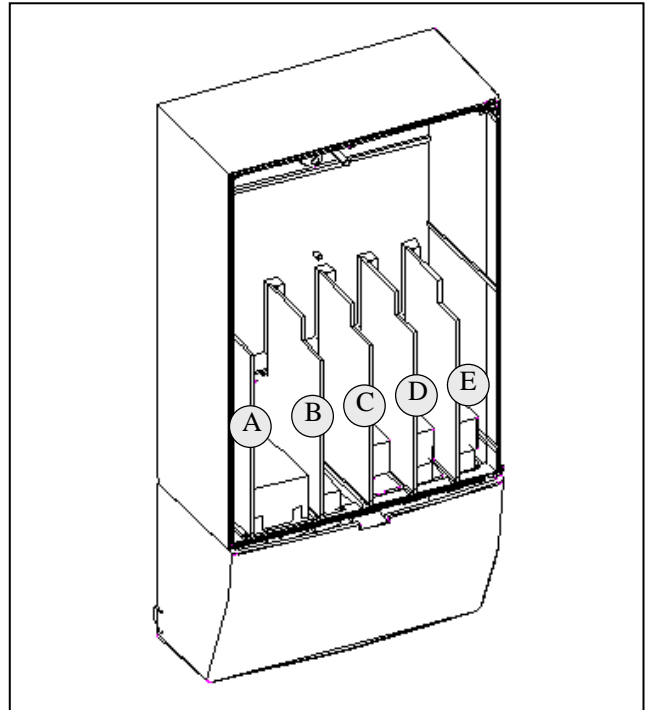
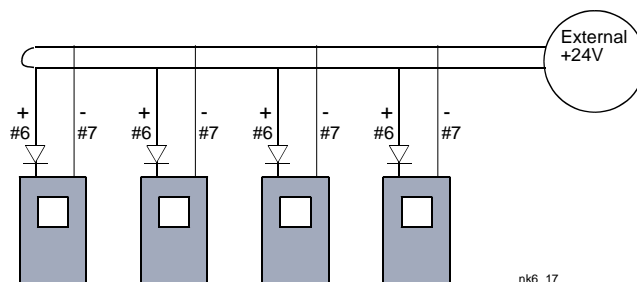

Figure 6-24. Basic and option board connections on the control board

Usually, when the frequency converter is delivered from the factory, the control unit includes at least the standard compilation of two basic boards (I/O board and relay board) which are normally installed in slots A and B. On the next pages you will find the arrangement of the [control I/O and the relay terminals](#) of the two basic boards, the [general wiring diagram](#) and the [control signal descriptions](#). The I/O boards mounted at the factory are indicated in the type code. For more information on the option boards, see Vacon NX option board manual (ud741).

The control board can be powered externally (+24V, $\pm 10\%$) by connecting the external power source to either of the bidirectional terminals #6 or #12, see page 69. This voltage is sufficient for parameter setting and for keeping the fieldbus active. Note however that the analogue inputs and outputs as well as the measurements of the main circuit (e.g. DC-link voltage, unit temperature) are not available when the mains is not connected (with the exception of frame size FR9 and bigger).

Note! If the 24V inputs of several frequency converters are parallelly connected we recommend to use a diode in terminal #6 (or #12) in order to avoid the current to flow in opposite direction. This might damage the control board. See picture below.



nk6_17

6.2.1 Control connections

The basic control connections for boards A1 and A2/A3 are shown in Chapter 6.2.2. The signal descriptions are presented in the All in One Application Manual.

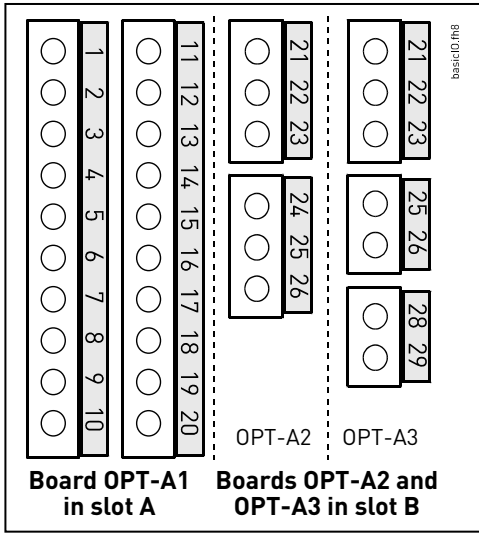

Figure 6-25. The I/O terminals of the two basic boards

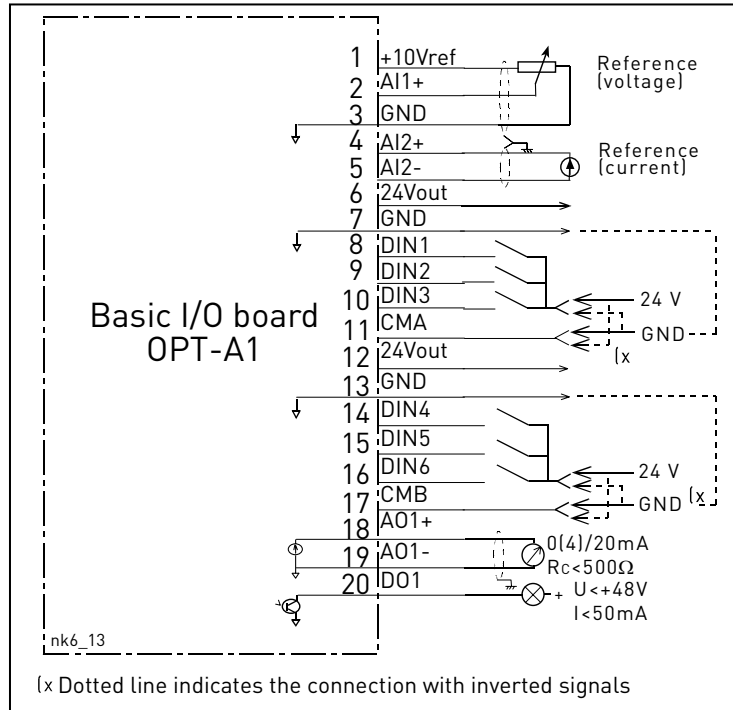

Figure 6-26. General wiring diagram of the basic I/O board (OPT-A1)

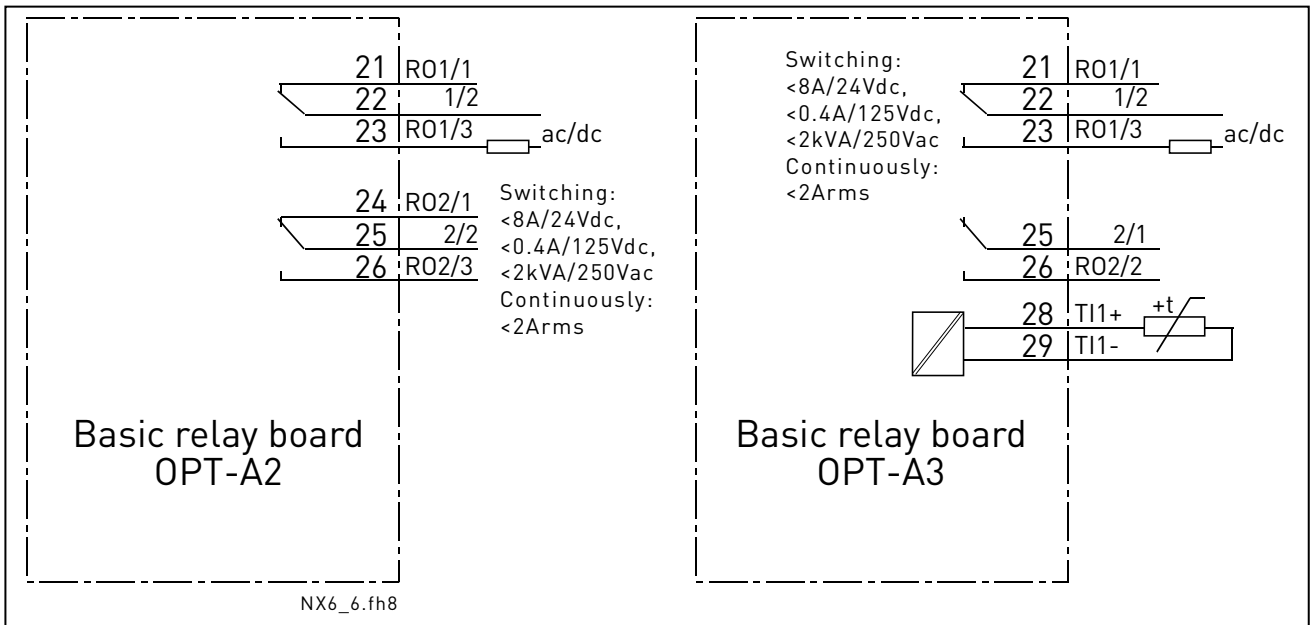

Figure 6-27. General wiring diagram of the basic relay boards (OPT-A2/OPT-A3)

6.2.1.1 Control cables

The control cables shall be at least 0.5 mm² screened multicore cables, see Table 6-1. The maximum terminal wire size is 2.5 mm² for the relay terminals and 1.5 mm² for other terminals.

Find the tightening torques of the option board terminals in Table below.

Terminal screw	Tightening torque	
	Nm	lb-in.
Relay and thermistor terminals (screw M3)	0.5	4.5
Other terminals (screw M2.6)	0.2	1.8

Table 6-8. Tightening torques of terminals

6.2.1.2 Galvanic isolation barriers

The control connections are isolated from the mains potential and the GND terminals are permanently connected to ground. See Figure 6-28.

The digital inputs are galvanically isolated from the I/O ground. The relay outputs are additionally double-isolated from each other at 300VAC (EN-50178).

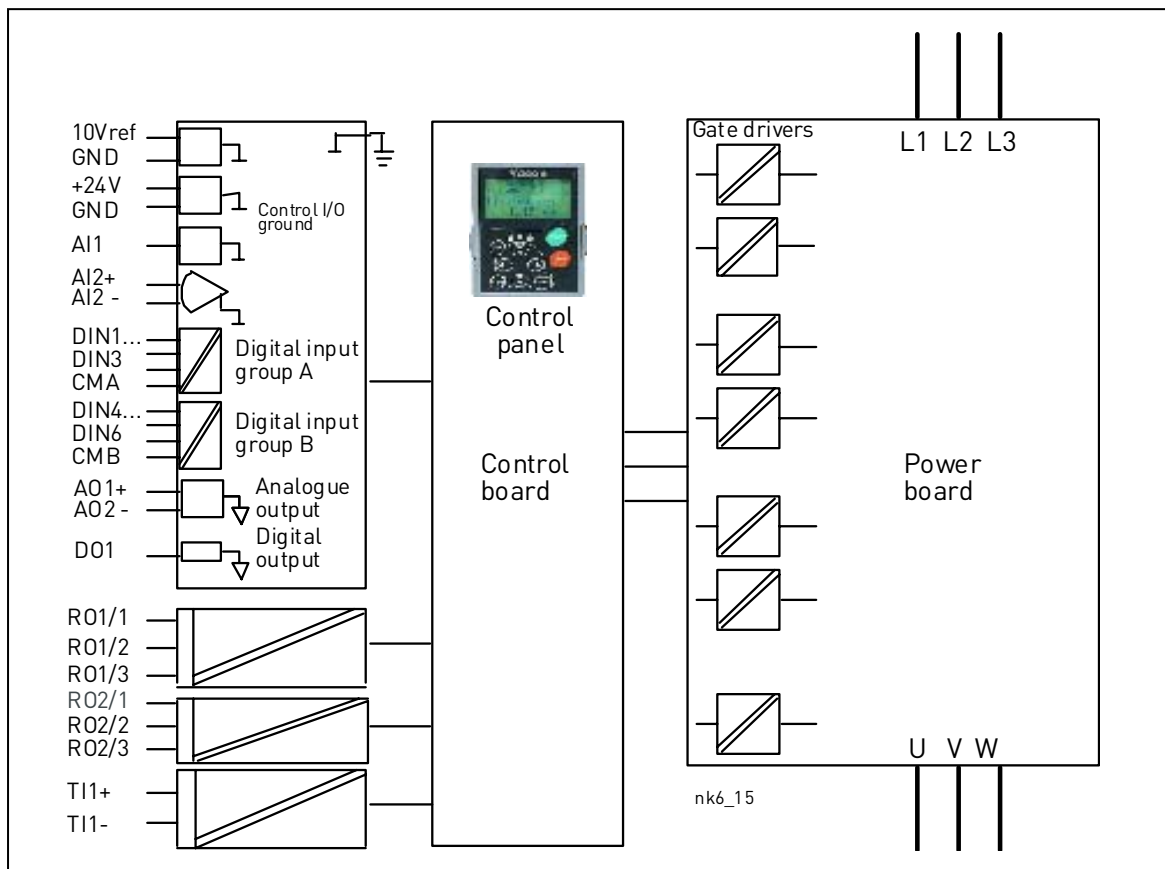

Figure 6-28. Galvanic isolation barriers

6.2.2 Control terminal signals

OPT-A1			
Terminal	Signal	Technical information	
1	+10 Vref	Reference voltage	Maximum current 10 mA
2	AI1+	Analogue input, voltage or current	Selection V or mA with jumper block X1 (see page 72): Default: 0– +10V ($R_i = 200\text{ k}\Omega$) (-10V.....+10V Joy-stick control, selected with a jumper) 0– 20mA ($R_i = 250\ \Omega$)
3	GND/AI1–	Analogue input common	Differential input if not connected to ground; Allows $\pm 20\text{V}$ differential mode voltage to GND
4	AI2+	Analogue input, voltage or current	Selection V or mA with jumper block X2 (see page 72): Default: 0– 20mA ($R_i = 250\ \Omega$) 0– +10V ($R_i = 200\text{ k}\Omega$) (-10V.....+10V Joy-stick control, selected with a jumper)
5	GND/AI2–	Analogue input common	Differential input if not connected to ground; Allows $\pm 20\text{V}$ differential mode voltage to GND
6	24 Vout (bidirectional)	24V auxiliary voltage	$\pm 15\%$, maximum current 250mA (all boards total); 150mA (from single board); Can also be used as external power backup for the control unit (and fieldbus)
7	GND	I/O ground	Ground for reference and controls
8	DIN1	Digital input 1	$R_i = \text{min. } 5\text{k}\Omega$ 18...30V = "1"
9	DIN2	Digital input 2	
10	DIN3	Digital input 3	
11	CMA	Digital input common A for DIN1, DIN2 and DIN3.	Must be connected to GND or 24V of I/O terminal or to external 24V or GND Selection with jumper block X3 (see page 72):
12	24 Vout (bidirectional)	24V auxiliary voltage	Same as terminal #6
13	GND	I/O ground	Same as terminal #7
14	DIN4	Digital input 4	$R_i = \text{min. } 5\text{k}\Omega$ 18...30V = "1"
15	DIN5	Digital input 5	
16	DIN6	Digital input 6	
17	CMB	Digital input common B for DIN4, DIN5 and DIN6	Must be connected to GND or 24V of I/O terminal or to external 24V or GND Selection with jumper block X3 (see page 72):
18	A01+	Analogue signal (+output)	Output signal range: Current 0(4)–20mA, $R_L \text{ max } 500\ \Omega$ or Voltage 0–10V, $R_L > 1\text{k}\Omega$ Selection with jumper block X6 (see page 72):
19	A01–	Analogue output common	
20	D01	Open collector output	Maximum $U_{in} = 48\text{VDC}$ Maximum current = 50 mA

Table 6-9. Control I/O terminal signals on basic I/O board OPT-A1

OPT-A2					
Terminal		Signal		Technical information	
21	R01/1		Relay output 1	Switching capacity	24VDC/8A
22	R01/2				250VAC/8A
23	R01/3				125VDC/0.4A
24	R02/1		Relay output 2	Switching capacity	24VDC/8A
25	R02/2				250VAC/8A
26	R02/3				125VDC/0.4A
				Min.switching load	5V/10mA

Table 6-10. Control I/O terminal signals on basic relay board OPT-A2

OPT-A3					
Terminal		Signal		Technical information	
21	R01/1		Relay output 1	Switching capacity	24VDC/8A
22	R01/2				250VAC/8A
23	R01/3				125VDC/0.4A
25	R02/1		Relay output 2	Switching capacity	24VDC/8A
26	R02/2				250VAC/8A
					125VDC/0.4A
				Min.switching load	5V/10mA
28	TI1+	Thermistor input			
29	TI1-				

Table 6-11. Control I/O terminal signals on basic relay board OPT-A3

6.2.2.1 Digital input signal inversions

The active signal level depends on which potential the common inputs CMA and CMB (terminals 11 and 17) are connected to. The alternatives are either +24V or ground (0 V). See Figure 6-29.

The 24-volt control voltage and the ground for the digital inputs and the common inputs (CMA, CMB) can be either internal or external.

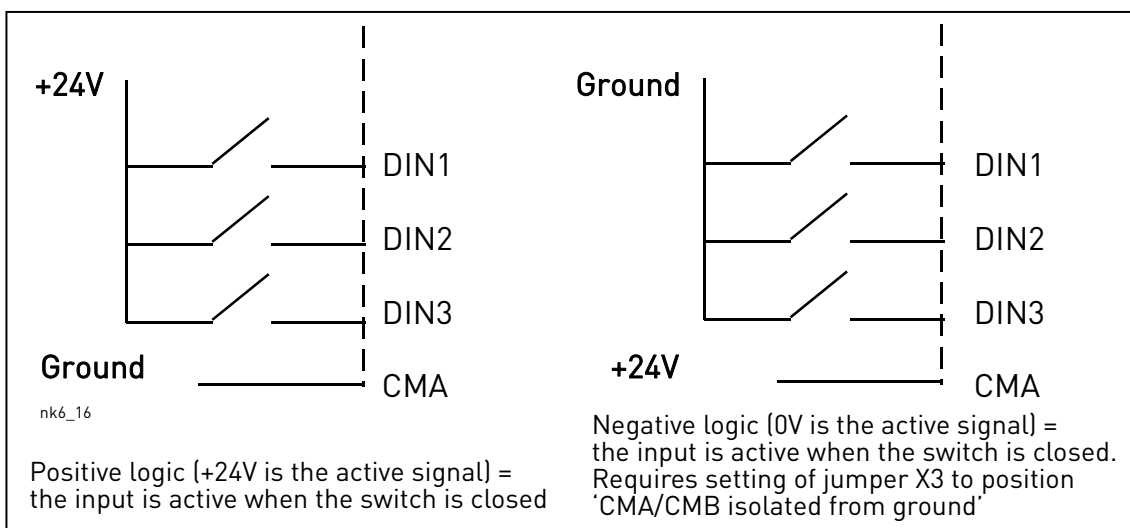

Figure 6-29. Positive/Negative logic

6.2.2.2 *Jumper selections on the OPT-A1 basic board*

The user is able to customise the functions of the frequency converter to better suit his needs by selecting certain positions for the jumpers on the OPT-A1 board. The positions of the jumpers determine the signal type of analogue and digital inputs.

On the A1 basic board, there are four jumper blocks X1, X2, X3 and X6 each containing eight pins and two jumpers. The selectable positions of the jumpers are shown in Figure 6-31.

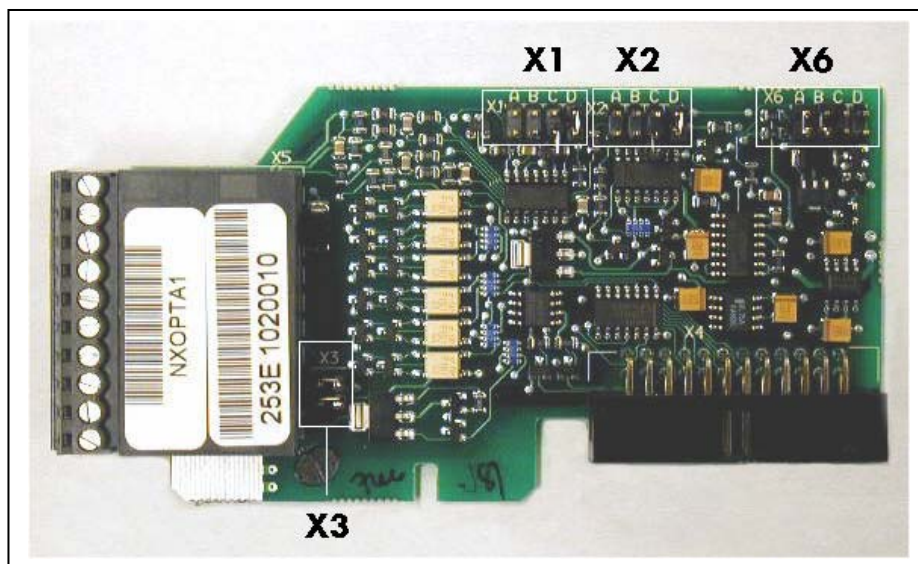

Figure 6-30. Jumper blocks on OPT-A1

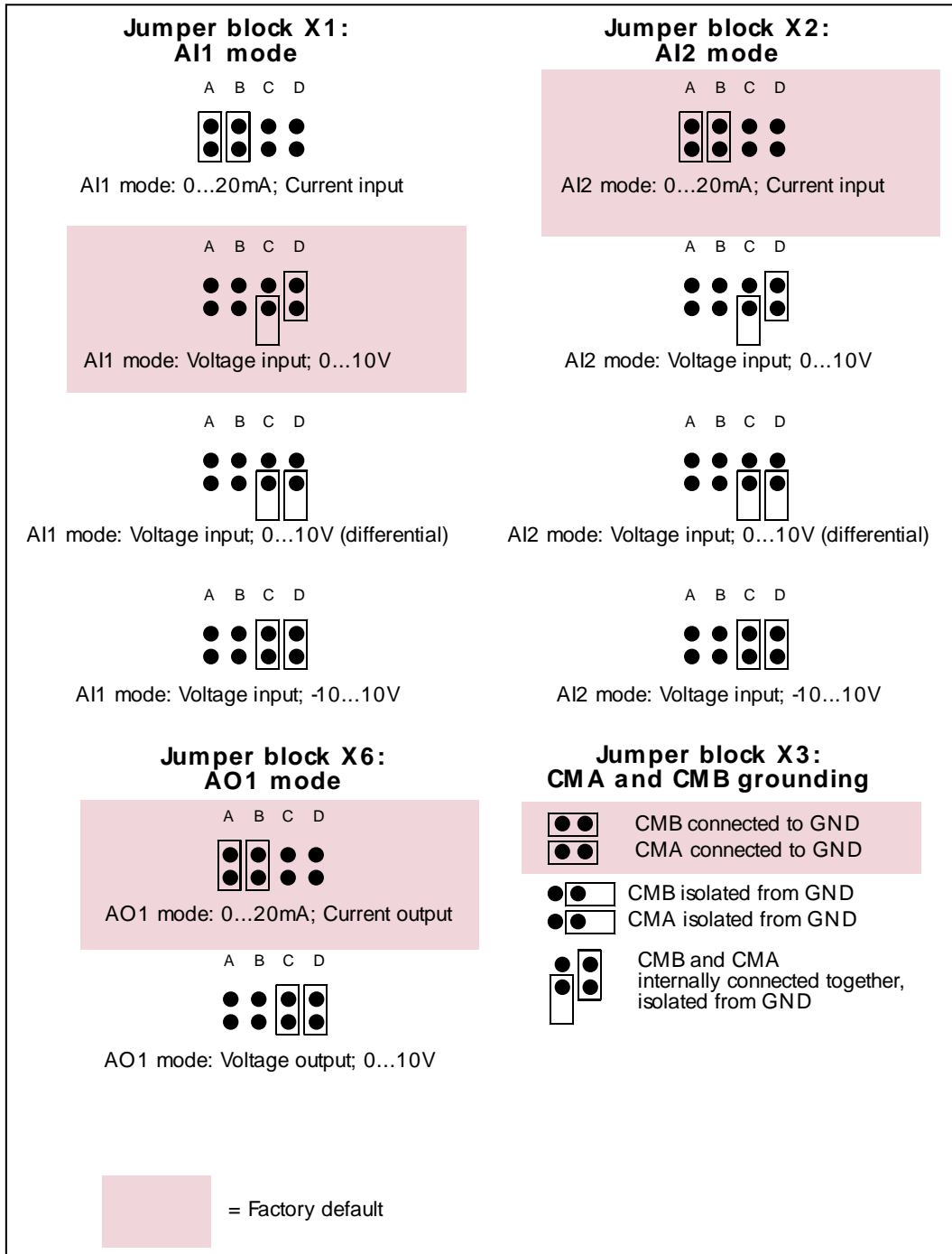



Figure 6-31. Jumper selection for OPT-A1

 NOTE	<p>If you change the AI/AO signal content also remember to change the corresponding board parameter in menu M7.</p>
--	---

7. CONTROL KEYPAD

The control keypad is the link between the Vacon frequency converter and the user. The Vacon NX control keypad features an alphanumeric display with seven indicators for the Run status (RUN, , READY, STOP, ALARM, FAULT) and three indicators for the control place (I/O term/ Keypad/BusComm). There are also three Status Indicator LEDs (green - green - red), see Status LEDs (green – green – red) below. The control information, i.e. the number of menu, description of menu or the displayed value and the numeric information are presented on three text lines.

The frequency converter is operable through the nine push-buttons of the control keypad. Furthermore, the buttons serve the purposes of parameter setting and value monitoring.

The keypad is detachable and isolated from the input line potential.

7.1 Indications on the Keypad display



Figure 7-1. Vacon control keypad and drive status indications



7.1.1 Drive status indications [\(See control keypad\)](#)

The drive status indications tell the user what the status of the motor and the drive is and whether the motor control software has detected irregularities in motor or frequency converter functions.

- 1 RUN = Motor is running; Blinks when the stop command has been given but the frequency is still ramping down.
- 2  = Indicates the direction of motor rotation.
- 3 STOP = Indicates that the drive is not running.
- 4 READY = Lights when AC power is on. In case of a trip, the symbol will not light up.
- 5 ALARM = Indicates that the drive is running outside a certain limit and a warning is given.
- 6 FAULT = Indicates that unsafe operating conditions were encountered due to which the drive was stopped.







7.1.2 Control place indications (See control keypad)

The symbols *I/O term*, *Keypad* and *Bus/Comm* (see Figure 7-1) indicate the choice of control place made in the Keypad control menu (M3) (see chapter 7.3.3).

-  *I/O term* = I/O terminals are the selected control place; i.e. START/STOP commands or reference values etc. are given through the I/O terminals.
-  *Keypad* = Control keypad is the selected control place; i.e. the motor can be started or stopped, or its reference values etc. altered from the keypad.
-  *Bus/Comm* = The frequency converter is controlled through a fieldbus.



7.1.3 Status LEDs (green – green – red) (See control keypad)

The status LEDs light up in connection with the READY, RUN and FAULT drive status indicators.

-   = Illuminates with the AC power connected to the drive and no faults are active. Simultaneously, the drive status indicator READY is lit up.
-   = Illuminates when the drive is running. Blinks when the STOP button has been pushed and the drive is ramping down.
-   = Blinks when unsafe operating conditions were encountered due to which the drive was stopped (Fault Trip). Simultaneously, the drive status indicator FAULT blinks on the display and the fault description can be seen, see chapter 7.3.4, Active Faults.

7.1.4 Text lines (See control keypad)

The three text lines (•, ••, •••) provide the user with information on his present location in the keypad menu structure as well as with information related to the operation of the drive.

-  = Location indication; displays the symbol and number of menu, parameter etc. Example: **M2** = Menu 2 (Parameters); **P2.1.3** = Acceleration time
-  = Description line; Displays the description of menu, value or fault.
-  = Value line; Displays the numerical and textual values of references, parameters etc. and the number of submenus available in each menu.

7.2 Keypad push-buttons

The Vacon alphanumeric control keypad features 9 push-buttons that are used for the control of the frequency converter (and motor), parameter setting and value monitoring.

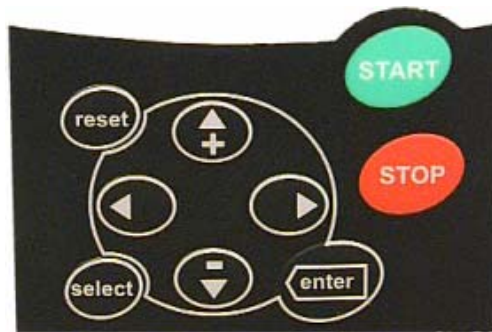











Figure 7-2. Keypad push-buttons

7.2.1 Button descriptions

-  = This button is used to reset active faults (see Chapter 7.3.4).
-  = This button is used to switch between two latest displays. May be useful when you want to see how the changed new value influences some other value.
-  = The Enter button serves for:
 - 1) confirmation of selections
 - 2) fault history reset (2...3 seconds)
-  = Browser button up
Browse the main menu and the pages of different submenus.
Edit values.
-  = Browser button down
Browse the main menu and the pages of different submenus.
Edit values.
-  = Menu button left
Move backward in menu.
Move cursor left (in [parameter menu](#)).
Exit edit mode.
Hold down for 3 seconds to return to main menu.
-  = Menu button right
Move forward in menu.
Move cursor right (in [parameter menu](#)).
Enter edit mode.
-  = Start button.
Pressing this button starts the motor if the keypad is the active control place. See Chapter 7.3.3.
-  = Stop button.
Pressing this button stops the motor (unless disabled by parameter R3.4/R3.6).
See Chapter 7.3.3.

7.3 Navigation on the control keypad

The data on the control keypad are arranged in menus and submenus. The menus are used for example for the display and editing of measurement and control signals, parameter settings (chapter 7.3.2), reference values and fault displays (chapter 7.3.4). Through the menus, you can also adjust the contrast of the display (page 100).

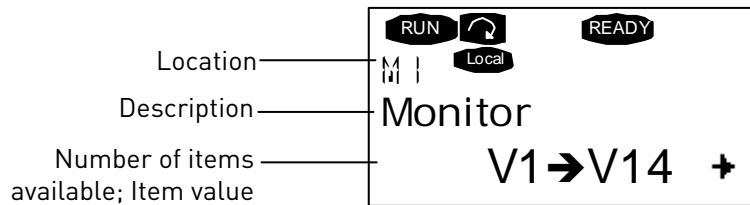

The first menu level consists of menus M1 to M7 and is called the *Main menu*. The user can navigate in the main menu using the *Browser buttons* up and down. The desired submenu can be entered from the main menu using the *Menu buttons*. When there still are pages to enter under the currently displayed menu or page, you can see an arrow (➔) in the lower right corner of the display and by pressing the *Menu button right*, you can reach the next menu level.

The control keypad navigation chart is shown on the next page. Please note that the menu **M1** is located in the lower left corner. From there you will be able to navigate your way up to the desired menu using the menu and browser buttons.

More detailed descriptions of the menus you will find later in this Chapter.

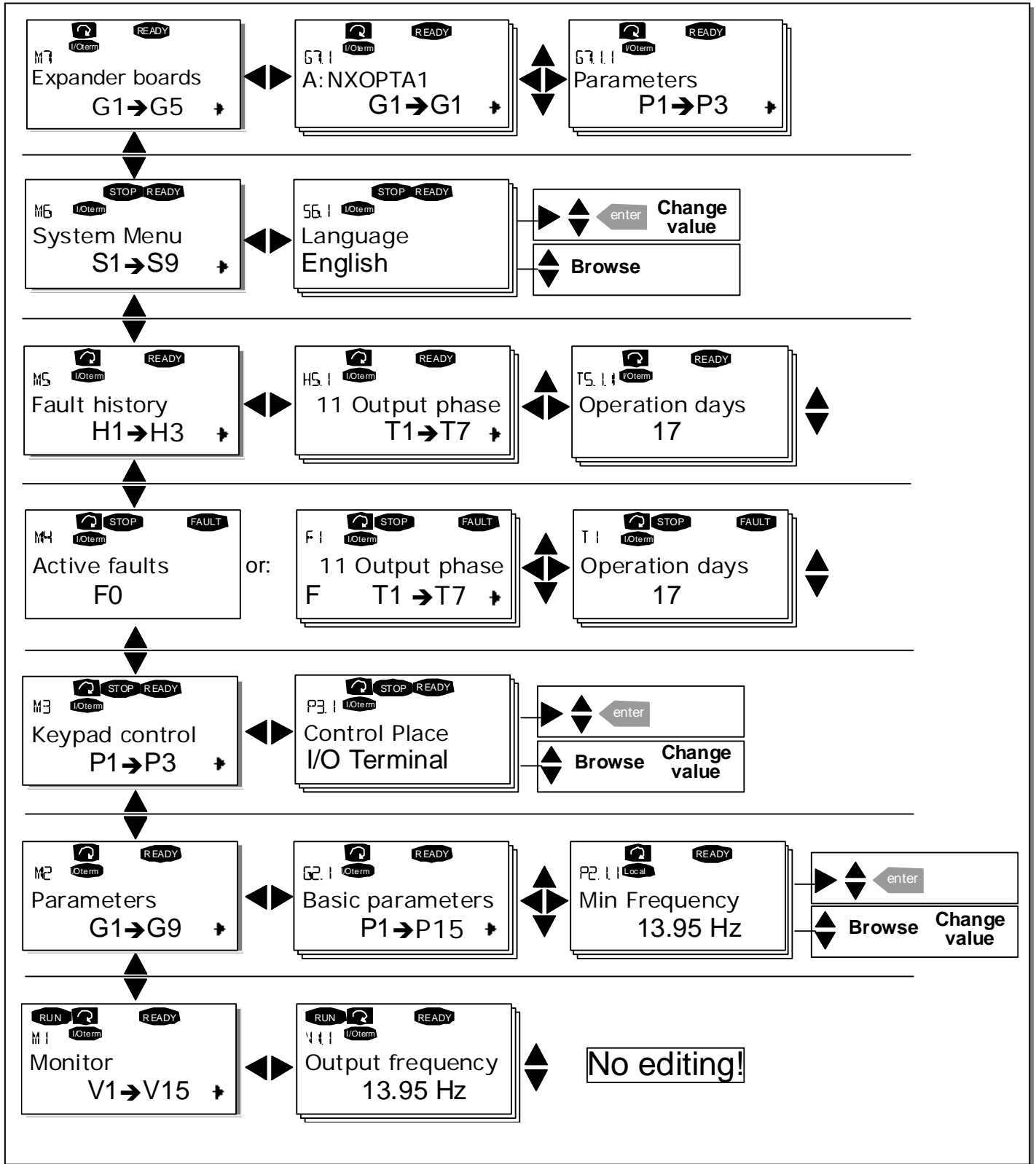

Figure 7-3. Keypad navigation chart

7.3.1 Monitoring menu (M1)

You can enter the Monitoring menu from the Main menu by pushing the *Menu button right* when the location indication **M1** is visible on the first line of the display. How to browse through the monitored values is presented in Figure 7-4.

The monitored signals carry the indication **V#.#** and they are listed in Table 7-1. The values are updated once every 0.3 seconds.

This menu is meant only for signal checking. The values cannot be altered here. For changing values of parameters see Chapter 7.3.2.

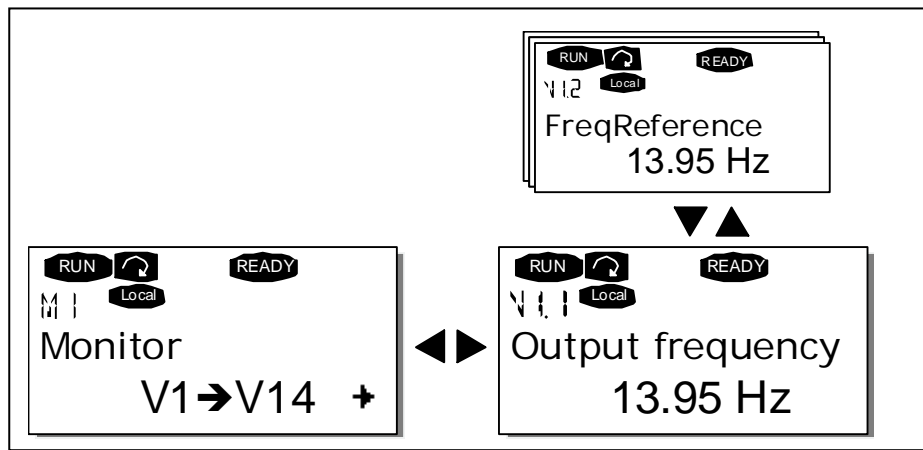

Figure 7-4. Monitoring menu

Code	Signal name	Unit	Description
V1.1	Output frequency	Hz	Frequency to the motor
V1.2	Frequency reference	Hz	
V1.3	Motor speed	rpm	Calculated motor speed
V1.4	Motor current	A	Measured motor current
V1.5	Motor torque	%	Calculated motor shaft torque
V1.6	Motor power	%	Calculated motor shaft power
V1.7	Motor voltage	V	Calculated motor voltage
V1.8	DC-link voltage	V	Measured DC-link voltage
V1.9	Unit temperature	°C	Heat sink temperature
V1.10	Motor temperature	%	Calculated motor temperature. See All in One application manual.
V1.11	Voltage input	V	A11*
V1.12	Current input	mA	A12*
V1.13	DIN1, DIN2, DIN3		Digital input statuses
V1.14	DIN4, DIN5, DIN6		Digital input statuses
V1.15	DO1, RO1, RO2		Digital and relay output statuses
V1.16	Analogue output	mA	A01
M1.17	Multimonitoring items		Displays three selectable monitoring values. See chapter 7.3.6.5.

Table 7-1. Monitored signals

* If the unit is supplied with +24V only (for control board power-up) this value is not reliable.

The All in One applications embody more monitoring values.

7.3.2 Parameter menu (M2)

Parameters are the way of conveying the commands of the user to the frequency converter. The parameter values can be edited by entering the *Parameter Menu* from the *Main Menu* when the location indication **M2** is visible on the first line of the display. The value editing procedure is presented in Figure 7-5.

Push the *Menu button right* once to move into the *Parameter Group Menu (G#)*. Locate the parameter group desired by using the *Browser buttons* and push the *Menu button right* again to enter the group and its parameters. Use again the *Browser buttons* to find the parameter (*P#*) you want to edit. From here you can proceed in two different ways: Pushing the *Menu button right* takes you to the edit mode. As a sign of this, the parameter value starts to blink. You can now change the value in two different manners:

- 1 Just set the new desired value with the *Browser buttons* and confirm the change with the *Enter button*. Consequently, the blinking stops and the new value is visible in the value field.
- 2 Push the *Menu button right* once again. Now you will be able to edit the value digit by digit. This editing manner may come in handy, when a relatively greater or smaller value than that on the display is desired. Confirm the change with the *Enter button*.

The value will not change unless the Enter button is pushed. Pressing the *Menu button left* takes you back to the previous menu.

Several parameters are locked, i.e. uneditable, when the drive is in RUN status. If you try to change the value of such a parameter the text **Locked** will appear on the display. The frequency converter must be stopped in order to edit these parameters.

The parameters values can also be locked using the function in menu **M6** (see Chapter Parameter lock (P6.5.2)).

You can return to the *Main menu* anytime by pressing the *Menu button left* for 3 seconds.

The basic application package "All in One+" includes seven applications with different sets of parameters. You will find the parameter lists in the Application Section of this manual.

Once in the last parameter of a parameter group, you can move directly to the first parameter of that group by pushing the *Browser button up*.

See the diagram for parameter value change procedure on page 80.

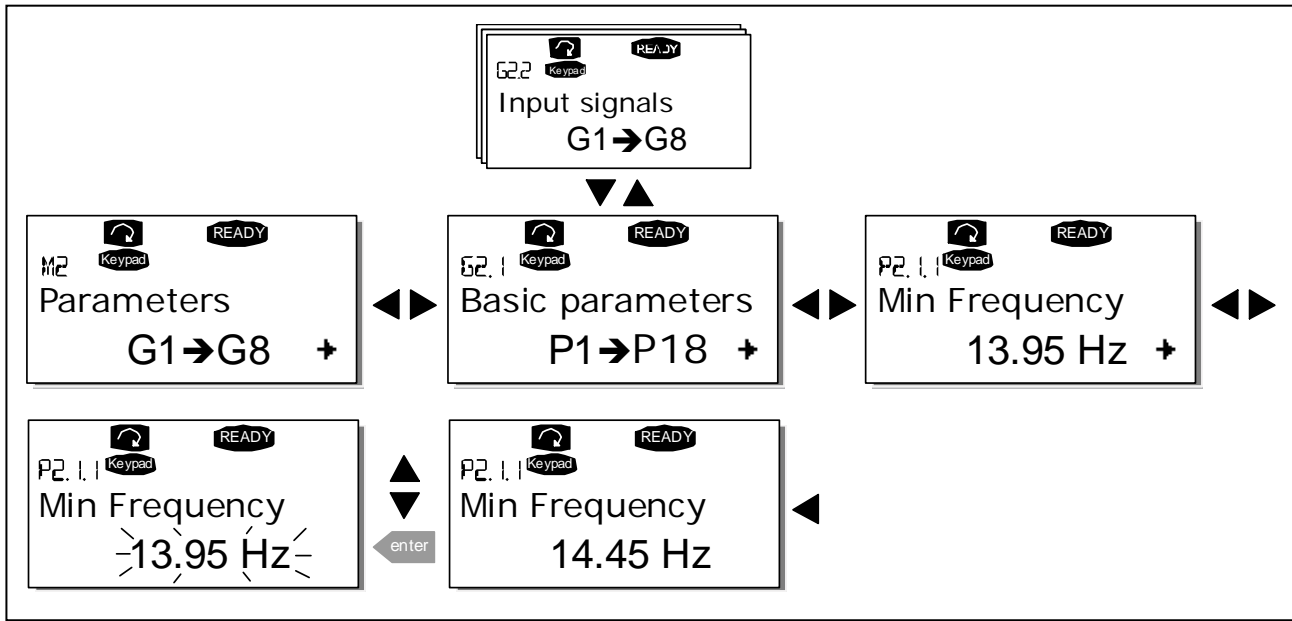

Figure 7-5. Parameter value change procedure

7.3.3 Keypad control menu (M3)

In the *Keypad Controls Menu*, you can choose the control place, edit the frequency reference and change the direction of the motor. Enter the submenu level with the *Menu button right*.

Code	Parameter	Min	Max	Unit	Default	Cust	ID	Note
P3.1	Control place	1	3		1		125	1=I/O terminal 2=Keypad 3=Fieldbus
R3.2	Keypad reference	Par. 2.1.1	Par. 2.1.2	Hz				
P3.3	Direction (on keypad)	0	1		0		123	0=Forward 1=Reverse
R3.4	Stop button	0	1		1		114	0=Limited function of Stop button 1=Stop button always enabled

Table 7-2. Keypad control parameters, M3

7.3.3.1 Selection of control place

There are three different places (sources) which the frequency converter can be controlled from. For each control place, a different symbol will appear on the alphanumeric display:

Control place	Symbol
I/O terminals	I/O term
Keypad (panel)	Keypad
Fieldbus	Bus/Comm

Change the control place by entering the edit mode with the *Menu button right*. The options can then be browsed through with the *Browser buttons*. Select the desired control place with the *Enter button*. See the diagram on the next page.

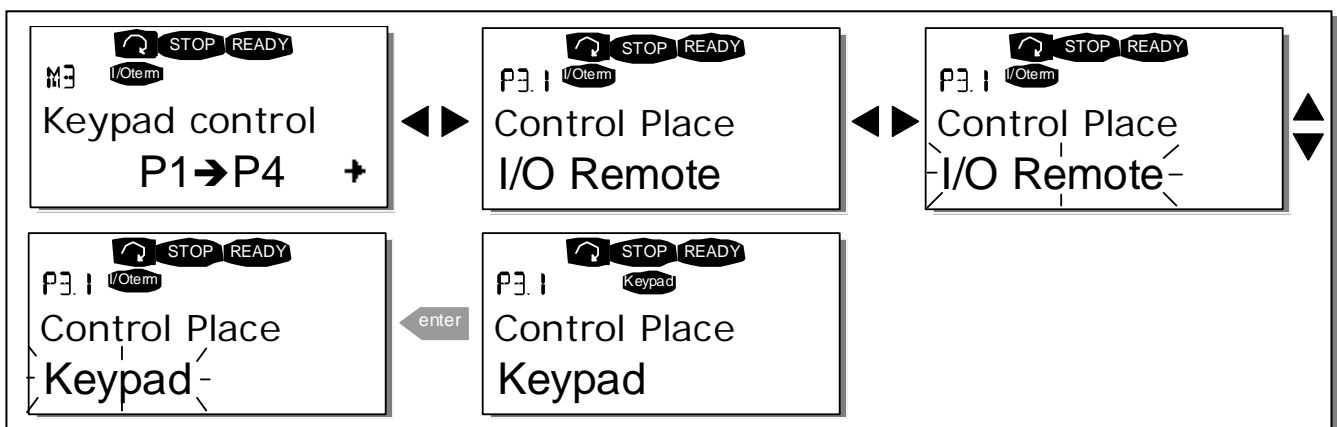

Figure 7-6. Selection of control place

7.3.3.2 Keypad reference

The keypad reference submenu (**P3.2**) displays and allows the operator to edit the frequency reference. The changes will take place immediately. **This reference value will not, however, influence the rotation speed of the motor unless the keypad has been selected as source of reference.**

NOTE: The maximum difference in RUN mode between the output frequency and the keypad reference is 6 Hz.

See Figure 7-5 for how to edit the reference value (pressing the *Enter button* is not, however, necessary).

7.3.3.3 Keypad direction

The keypad direction submenu displays and allows the operator to change the rotating direction of the motor. **This setting will not, however, influence the rotation direction of the motor unless the keypad has been selected as the active control place.**

See Figure 7-6 for how to change the rotation direction.

Note: Additional Information on controlling the motor with the keypad is given in Chapters 7.2.1 and 8.2

7.3.3.4 Stop button activated

By default, pushing the STOP button will **always** stop the motor regardless of the selected control place. You can disable this function by giving parameter 3.4 the value **0**. If the value of this parameter is **0**, the STOP button will stop the motor only **when the keypad has been selected as the active control place.**

NOTE! There are some special functions that can be performed when in menu **M3**:

Select the keypad as the active control place by keeping the  button pushed down for 3 seconds **when the motor is running**. The keypad will become the active control place and the current frequency reference and direction will be copied to the keypad.

Select the keypad as the active control place by keeping the  button pushed down for 3 seconds **when the motor is stopped**. The keypad will become the active control place and the current frequency reference and direction will be copied to the keypad.

Copy the frequency reference set elsewhere (I/O, fieldbus) to the panel by keeping the  button pushed down for 3 seconds.

Note that if you are in any other than **M3** menu these functions will not work.

If you are in some other than **M3** menu and try to start the motor by pressing the START button when the keypad is not selected as the active control place you will get an error message *Keypad Control NOT ACTIVE*.

7.3.4 Active faults menu (M4)

The *Active faults menu* can be entered from the *Main menu* by pushing the *Menu button right* when the location indication **M4** is visible on the first line of the keypad display.

When a fault brings the frequency converter to a stop, the location indication F1, the fault code, a short description of the fault and the **fault type symbol** (see Chapter 7.3.4.1) will appear on the display. In addition, the indication FAULT or ALARM (see Figure 7-1 or Chapter 7.1.1) is displayed and, in case of a FAULT, the **red led** on the keypad starts to blink. If several faults occur simultaneously, the list of active faults can be browsed with the *Browser buttons*.

The memory of active faults can store the maximum of 10 faults in the order of appearance. The display can be cleared with the *Reset button* and the read-out will return to the same state it was before the fault trip. The fault remains active until it is cleared with the *Reset button* or with a reset signal from the I/O terminal or fieldbus.

Note! Remove external Start signal before resetting the fault to prevent unintentional restart of the drive.

Normal state,
no faults:



7.3.4.1 *Fault types*

In the NX_ frequency converter, there are four different types of faults. These types differ from each other on the basis of the subsequent behaviour of the drive. See Table 7-3.

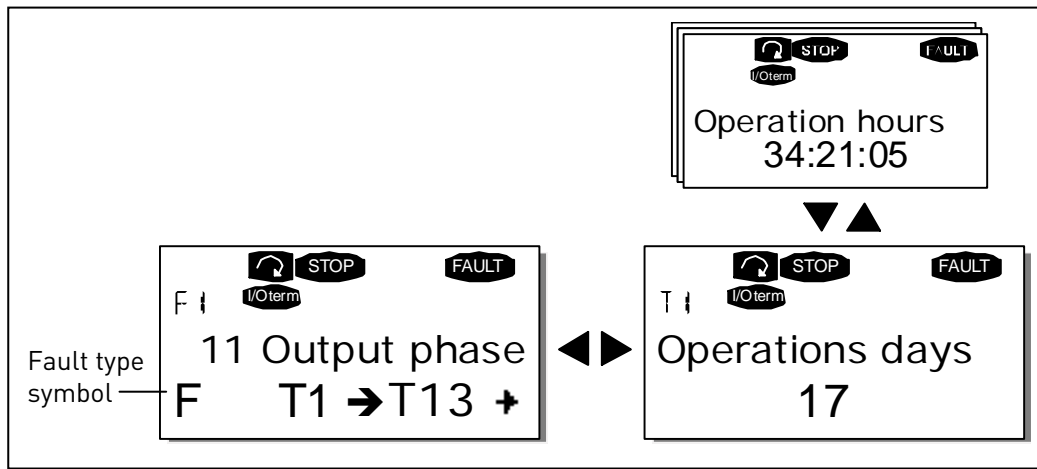

Figure 7-7. Fault display

Fault type symbol	Meaning
A (Alarm)	This type of fault is a sign of an unusual operating condition. It does not cause the drive to stop, nor does it require any special actions. The 'A fault' remains in the display for about 30 seconds.
F (Fault)	An 'F fault' is a kind of fault that makes the drive stop. Actions need to be taken in order to restart the drive.
AR (Fault Autoreset)	If an 'AR fault' occurs the drive will also stop immediately. The fault is reset automatically and the drive tries to restart the motor. Finally, if the restart is not successful, a fault trip (FT, see below) occurs.
FT (Fault Trip)	If the drive is unable to restart the motor after an AR fault an FT fault occurs. The effect of the 'FT fault' is basically the same as that of the F fault: the drive is stopped.

Table 7-3. Fault types

7.3.4.2 *Fault codes*

The fault codes, their causes and correcting actions are presented in the table below. The shadowed faults are A faults only. The items written in white on black background present faults for which you can program different responses in the application. See parameter group Protections.

Note: When contacting distributor or factory because of a fault condition, always write down all texts and codes on the keypad display.

Fault code	Fault	Possible cause	Correcting measures
1	Overcurrent	Frequency converter has detected too high a current ($>4 \cdot I_M$) in the motor cable: <ul style="list-style-type: none"> – sudden heavy load increase – short circuit in motor cables – unsuitable motor Subcode in T.14: S1 = Hardware trip S2 = Reserved S3 = Current controller supervision	Check loading. Check motor. Check cables. Make identification run.
2	Overvoltage	The DC-link voltage has exceeded the limits defined. <ul style="list-style-type: none"> – too short a deceleration time – high overvoltage spikes in supply Subcode in T.14: S1 = Hardware trip S2 = Overvoltage control supervision	Make deceleration time longer. Use brake chopper or brake resistor (available as options) Activate overvoltage controller. Check input voltage.
3	Earth fault	Current measurement has detected that the sum of motor phase current is not zero. <ul style="list-style-type: none"> – insulation failure in cables or motor 	Check motor cables and motor.
5	Charging switch	The charging switch is open, when the START command has been given. <ul style="list-style-type: none"> – faulty operation – component failure 	Reset the fault and restart. Should the fault re-occur, contact the distributor near to you. See Vacon contact info on the Web .
6	Emergency stop	Stop signal has been given from the option board.	Check emergency stop circuit.
7	Saturation trip	Various causes: <ul style="list-style-type: none"> – defective component – brake resistor short-circuit or overload 	Cannot be reset from the keypad. Switch off power. DO NOT RE-CONNECT POWER! Contact factory. If this fault appears simultaneously with Fault 1, check motor cables and motor
8	System fault	- component failure - faulty operation Note exceptional fault data record. S1 = Reserved S2 = Reserved S3 = Reserved S4 = Reserved S5 = Reserved S6 = Reserved S7 = Charging switch S8 = No power to driver card S9 = Power unit communication (TX) S10 = Power unit communication (Trip) S11 = Power unit comm. (Measurement)	Reset the fault and restart. Should the fault re-occur, contact the distributor near to you. See Vacon contact info on the Web .

Fault code	Fault	Possible cause	Correcting measures
9	Undervoltage	DC-link voltage is under the voltage limits defined. <ul style="list-style-type: none"> – most probable cause: too low a supply voltage – frequency converter internal fault – defect input fuse – external charge switch not closed Subcode in T.14: S1 = DC-link too low during run S2 = No data from power unit S3 = Undervoltage control supervision	In case of temporary supply voltage break reset the fault and restart the frequency converter. Check the supply voltage. If it is adequate, an internal failure has occurred. Contact the distributor near to you. See Vacon contact info on the Web.
10	Input line supervision	Input line phase is missing.	Check supply voltage, fuses and cable.
11	Output phase supervision	Current measurement has detected that there is no current in one motor phase.	Check motor cable and motor.
12	Brake chopper supervision	<ul style="list-style-type: none"> – no brake resistor installed – brake resistor is broken – brake chopper failure 	Check brake resistor and cabling. If the these are ok, the chopper is faulty. Contact the distributor near to you. See Vacon contact info on the Web .
13	Frequency converter under-temperature	Heatsink temperature is under -10°C	
14	Frequency converter over-temperature	Heatsink temperature is over 90°C (or 77°C , NX_6, FR6). Overtemperature warning is issued when the heatsink temperature exceeds 85°C (72°C).	Check the correct amount and flow of cooling air. Check the heatsink for dust. Check the ambient temperature. Make sure that the switching frequency is not too high in relation to ambient temperature and motor load.
15	Motor stalled	Motor stall protection has tripped.	Check motor and load.
16	Motor over-temperature	Motor overheating has been detected by frequency converter motor temperature model. Motor is overloaded.	Decrease motor load. If no motor overload exists, check the temperature model parameters.
17	Motor underload	Motor underload protection has tripped.	Check load.
18	Unbalance	Unbalance between power modules in paralleled units. Subcode in T.14: S1 = Current unbalance S2 = DC voltage unbalance	Should the fault re-occur, contact the distributor near to you.
22	EEPROM checksum fault	Parameter save fault <ul style="list-style-type: none"> – faulty operation – component failure 	Should the fault re-occur, contact the distributor near to you.
24	Counter fault	Values displayed on counters are incorrect	
25	Microprocessor watchdog fault	<ul style="list-style-type: none"> – faulty operation – component failure 	Reset the fault and restart. Should the fault re-occur, contact the distributor near to you. See Vacon contact info on the Web .
26	Start-up prevented	Start-up of the drive has been prevented. Run request in ON when new application is loaded to the drive	Cancel prevention of start-up if this can be done safely. Remove Run request

Fault code	Fault	Possible cause	Correcting measures
29	Thermistor fault	The thermistor input of option board has detected increase of the motor temperature	Check motor cooling and loading Check thermistor connection (If thermistor input of the option board is not in use it has to be short circuited)
30	Safe disable	The input on OPT-AF board has opened	Cancel Safe Disable if this can be done safely.
31	IGBT temperature (hardware)	IGBT Inverter Bridge overtemperature protection has detected too high a short term overload current	Check loading. Check motor size. Make identification run.
32	Fan cooling	Cooling fan of the frequency converter does not start, when ON command is given	Contact the distributor near to you. See Vacon contact info on the Web .
34	CAN bus communication	Sent message not acknowledged.	Ensure that there is another device on the bus with the same configuration.
35	Application	Problem in application software	Contact your distributor. If you are application programmer check the application program.
36	Control unit	NXS Control Unit can not control NXP Power Unit and vice versa	Change control unit
37	Device changed (same type)	Option board or control unit changed. Same type of board or same power rating of drive.	Reset. Device is ready for use. Old parameter settings will be used.
38	Device added (same type)	Option board or drive added.	Reset. Device is ready for use. Old board settings will be used.
39	Device removed	Option board removed.	Reset. Device no longer available.
40	Device unknown	Unknown option board or drive. Subcode in T.14 : S1 = Unknown device S2 = Power1 not same type as Power2	Contact the distributor near to you. See Vacon contact info on the Web .
41	IGBT temperature	IGBT Inverter Bridge overtemperature protection has detected too high a short term overload current	Check loading. Check motor size. Make identification run.
42	Brake resistor overtemperature	Brake resistor overtemperature protection has detected too heavy braking	Set the deceleration time longer. Use external brake resistor.
43	Encoder fault	Problem detected in encoder signals. Subcode in T.14 : 1 = Encoder 1 channel A is missing 2 = Encoder 1 channel B is missing 3 = Both encoder 1 channels are missing 4 = Encoder reversed 5 = Encoder board missing	Check encoder channel connections. Check the encoder board. Check encoder frequency in open loop.
44	Device changed (different type)	Option board or power unit changed. New device of different type or different power rating.	Reset Set the option board parameters again if option board was changed. Set converter parameters again if power unit was changed.
45	Device added (different type)	Option board of different type added.	Reset Set the option board parameters again.
49	Division by zero in application	Division by zero has occurred in application program.	Contact your distributor if the fault re-occurs while the converter is in run state. If you are application programmer check the application program.

Fault code	Fault	Possible cause	Correcting measures
50	Analogue input $I_{in} < 4\text{mA}$ (sel. signal range 4 to 20 mA)	Current at the analogue input is $< 4\text{mA}$. – control cable is broken or loose – signal source has failed	Check the current loop circuitry.
51	External fault	Digital input fault.	Remove fault situation on external device.
52	Keypad communication fault	The connection between the control keypad (or NCDrive) and the frequency converter is broken.	Check keypad connection and possible keypad cable.
53	Fieldbus fault	The data connection between the fieldbus Master and the fieldbus board is broken	Check installation. If installation is correct contact the nearest Vacon distributor. See Vacon contact info on the Web .
54	Slot fault	Defective option board or slot	Check board and slot. Contact the nearest Vacon distributor. See Vacon contact info on the Web .
56	PT100 board temp. fault	Temperature limit values set for the PT100 board parameters have been exceeded	Find the cause of temperature rise
57	Identification	Identification run has failed.	Run command was removed before completion of identification run. Motor is not connected to frequency converter. There is load on motor shaft.
58	Brake	Actual status of the brake is different from the control signal.	Check mechanical brake state and connections.
59	Follower communication	SystemBus or CAN communication is broken between Master and Follower	Check option board parameters. Check optical fibre cable or CAN cable.
60	Cooling	Coolant circulation on liquid-cooled drive has failed.	Check reason for the failure on external system.
61	Speed error	Motor speed is unequal to reference	Check encoder connection. PMS motor has exceeded the pull out torque.
62	Run disable	Run enable signal is low	Check reason for Run enable signal.
63	Emergency stop	Command for emergency stop received from digital input or fieldbus	New run command is accepted after reset.
64	Input switch open	Drive input switch is open	Check the main power switch of the drive.

Table 7-4. Fault codes

7.3.4.3 *Fault time data record*

When a fault occurs the information described above in 7.3.4 is displayed. By pushing the *Menu button right* here you will enter the *Fault time data record menu* indicated by T.1→T.13. In this menu, some selected important data valid at the time of the fault are recorded. This feature is intended to help the user or the service person to determine the cause of fault.

The data available are:

T.1	Counted operation days (Fault 43: Additional code)	d
T.2	Counted operation hours (Fault 43: Counted operation days)	hh:mm:ss (d)
T.3	Output frequency (Fault 43: Counted operation hours)	Hz (hh:mm:ss)
T.4	Motor current	A
T.5	Motor voltage	V
T.6	Motor power	%
T.7	Motor torque	%
T.8	DC voltage	V
T.9	Unit temperature	°C
T.10	Run status	
T.11	Direction	
T.12	Warnings	
T.13	0-speed*	

Table 7-5. Fault time recorded data

* Tells the user if the drive was at zero speed (< 0.01 Hz) when the fault occurred

Real time record

If real time is set to run on the frequency converter the data items T1 and T2 will appear as follows:

T.1	Counted operation days	yyyy-mm-dd
T.2	Counted operation hours	hh:mm:ss,s ss

7.3.5 Fault history menu (M5)

The *Fault history menu* can be entered from the *Main menu* by pushing the *Menu button right* when the location indication **M5** is visible on the first line of the keypad display. Find the fault codes in Table 7-4.

All faults are stored in the *Fault history menu* in which you can browse through them using the *Browser buttons*. Additionally, the *Fault time data record* pages (see Chapter 7.3.4.3) are accessible at each fault. You can return to the previous menu anytime by pushing the *Menu button left*.

The memory of the frequency converter can store a maximum of 30 faults in the order of appearance. The number of faults currently in the fault history is shown on the *value line* of the main page (**H1→H#**). The order of the faults is indicated by the *location indication* in the upper left corner of the display. The latest fault carries the indication F5.1, the second latest F5.2 etc. If there are 30 uncleared faults in the memory the next occurring fault will erase the oldest from the memory.

Pressing the *Enter button* for about 2 to 3 seconds resets the whole fault history. Then, the symbol **H#** will change to **0**.

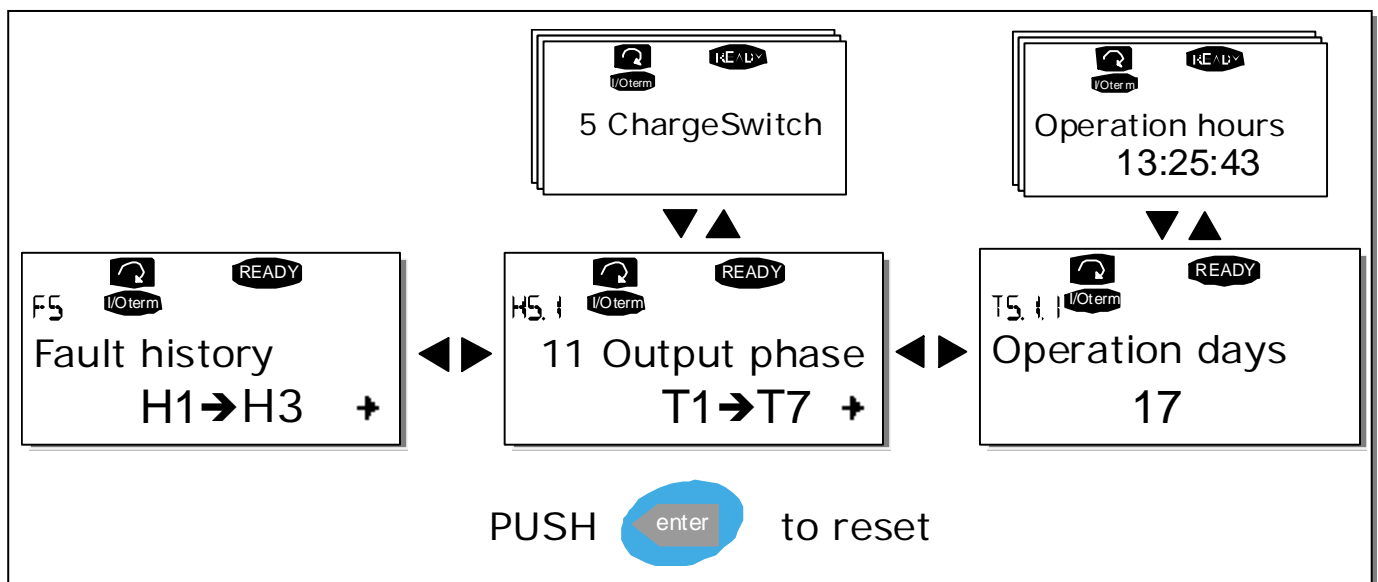

Figure 7-8. Fault history menu

7.3.6 System menu (M6)

The *System menu* can be entered from the main menu by pushing the *Menu button right* when the location indication **M6** is visible on the display.

The controls associated with the general use of the frequency converter, such as application selection, customised parameter sets or information about the hardware and software are located under the *System menu*. The number of submenus and subpages is shown with the symbol **S** (or **P**) on the *value line*.

On page 91 you will find a list of the functions available in the System menu.

Functions in the System menu

Code	Function	Min	Max	Unit	Default	Cust	Selections
S6.1	Language selection				English		Available selections depend on the language package.
S6.2	Application selection				Basic Application		Basic Application Standard Application Local/Remote control Appl. Multi-Step Application PID Control Application Multi-Purpose Control Appl. Pump and Fan Control Appl.
S6.3	Copy parameters						
S6.3.1	Parameter sets						Store set 1 Load set 1 Store set 2 Load set 2 Load factory defaults
S6.3.2	Load up to keypad						All parameters
S6.3.3	Load down from keypad						All parameters All but motor parameters Application parameters
P6.3.4	Parameter backup				Yes		Yes No
S6.4	Compare parameters						
S6.4.1	Set1				Not used		
S6.4.2	Set2				Not used		
S6.4.3	Factory settings						
S6.4.4	Keypad set						
S6.5	Security						
S6.5.1	Password				Not used		0=Not used
P6.5.2	Parameter lock				Change Enabled		Change Enabled Change Disabled
S6.5.3	Start-up wizard						No Yes
S6.5.4	Multimonitoring items						Change Enabled Change Disabled
S6.6	Keypad settings						
P6.6.1	Default page						
P6.6.2	Default page/ Operating menu						
P6.6.3	Timeout time	0	65535	s	30		
P6.6.4	Contrast	0	31		18		
P6.6.5	Backlight time	Always	65535	min	10		
S6.7	Hardware settings						
P6.7.1	Internal brake resistor				Connected		Not connected Connected

P6.7.2	Fan control				Continuous		Continuous Temperature
P6.7.3	HMI acknowledg. timeout	200	5000	ms	200		
P6.7.4	HMI number of retries	1	10		5		
S6.8	System information						
S6.8.1	Total counters						
C6.8.1.1	MWh counter			kWh			
C6.8.1.2	Power On day counter						
C6.8.1.3	Power On hours counter			hh:mm:ss			
S6.8.2	Trip counters						
T6.8.2.1	MWh counter			kWh			
T6.8.2.2	Clear MWh trip counter						
T6.8.2.3	Operating days trip counter						
T6.8.2.4	Operating hours trip counter			hh:mm:ss			
T6.8.2.5	Clear operating time counter						
S6.8.3	Software info						
S6.8.3.1	Software package						
S6.8.3.2	System software version						
S6.8.3.3	Firmware interface						
S6.8.3.4	System load						
S6.8.4	Applications						
S6.8.4.#	<i>Name of application</i>						
D6.8.4.#.1	Application ID						
D6.8.4.#.2	Applications: Version						
D6.8.4.#.3	Applications: Firmware interface						
S6.8.5	Hardware						
I6.8.5.1	Info: Power unit type code						
I6.8.5.2	Info: Unit voltage			V			
I6.8.5.3	Info: Brake chopper						
I6.8.5.4	Info: Brake resistor						
S6.8.6	Expander boards						
S6.8.7	Debug menu						For Application programming only. Contact factory for more details

Table 7-6. System menu functions

7.3.6.1 Language selection

The Vacon control keypad offers you the possibility to control the frequency converter through the keypad in the language of your choice.

Locate the language selection page under the *System menu*. Its location indication is **S6.1**. Press the *Menu button right* once to enter the edit mode. As the name of the language starts to blink you are able to choose another language for the keypad texts. Confirm the selection by pushing the *Enter button*. The blinking stops and all textual information on the keypad is presented in the language you chose.

You can return to the previous menu anytime by pushing the *Menu button left*.

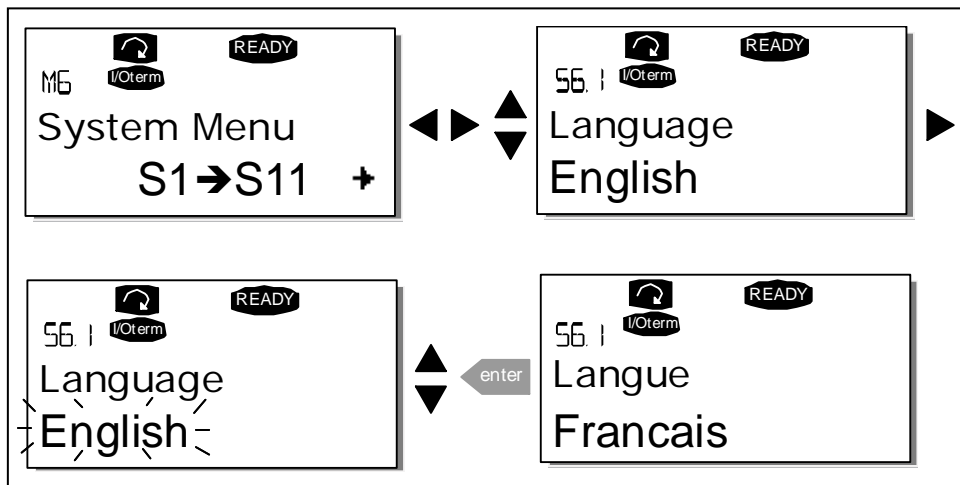

Figure 7-9. Selection of language

7.3.6.2 Application selection

The user can select the application desired by entering the *Application selection page (S6.2)*. This is done by pushing the *Menu button right* when on the first page of the *System menu*. Change then the application by pushing the *Menu button right* once again. The name of the application starts to blink. Now you can browse through the applications with the *Browser buttons* and select another application with the *Enter button*.

Changing application will reset all parameters. After application change, you will be asked if you want the parameters of the **new** application to be uploaded to the keypad. If you wish this to happen push the *Enter button*. Pushing any other button leaves the parameters of the **previously used** application saved in the keypad. For more information, see Chapter 7.3.6.3.

For more information about the Application Package, see Vacon NX Application Manual.

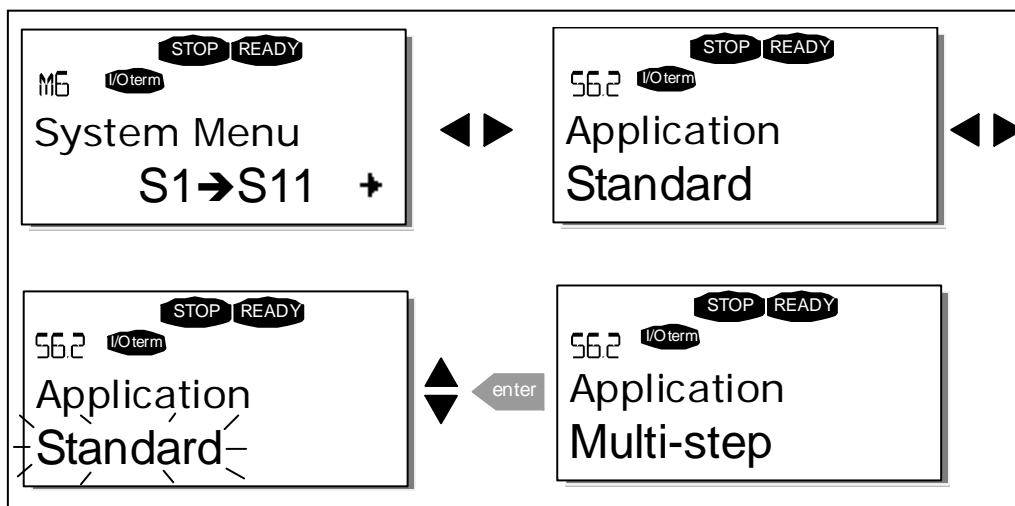

Figure 7-10. Change of application

7.3.6.3 Copy parameters

The parameter copy function is used when the operator wants to copy one or all parameter groups from one drive to another or to store parameter sets in the internal memory of the converter. All the parameter groups are first *uploaded* to the keypad, then the keypad is connected to another drive and then the parameter groups are *downloaded* to it (or possibly back to the same drive).

Before any parameters can successfully be copied from one drive to another the **drive** has to be **stopped** when the parameters are downloaded to it:

The parameter copy menu (**S6.3**) embodies four functions:

Parameter sets (S6.3.1)

The Vacon NX_ frequency converter features a possibility for the user to load back the factory default parameter values and to store and load two customised parameter sets (all parameters included in the application).

On *Parameter sets* page (**S6.3.1**), push the *Menu button right* to enter the *Edit menu*. The text *LoadFactDef* begins to blink and you can confirm the loading of factory defaults by pushing the *Enter button*. The drive resets automatically.

Alternatively you can choose any other of the storing or loading functions with the *Browser buttons*. Confirm with the *Enter button*. Wait until 'OK' appears on the display.

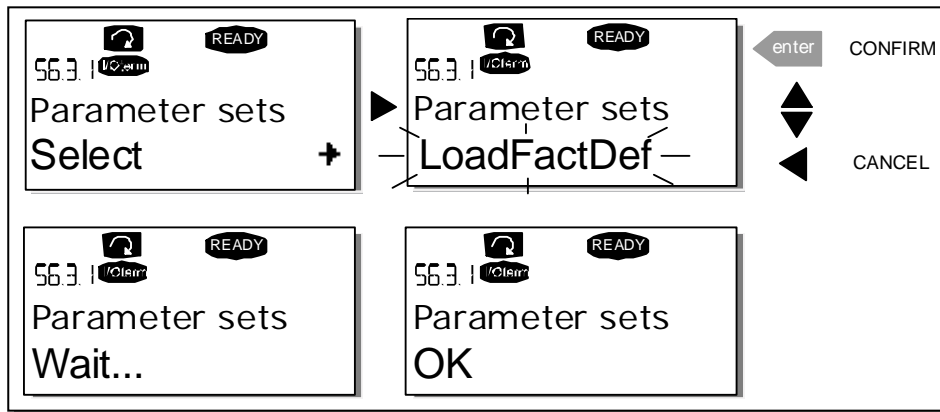

Figure 7-11. Storing and loading of parameter sets

Upload parameters to keypad (To keypad, S6.3.2)

This function uploads **all** existing parameter groups to the keypad provided that the drive is stopped.

Enter the *To keypad* page (S6.3.2) from the *Parameter copy menu*. Push the *Menu button right* to enter the edit mode. Use the *Browser buttons* to select the option *All parameters* and press the *Enter button*. Wait until 'OK' appears on the display.

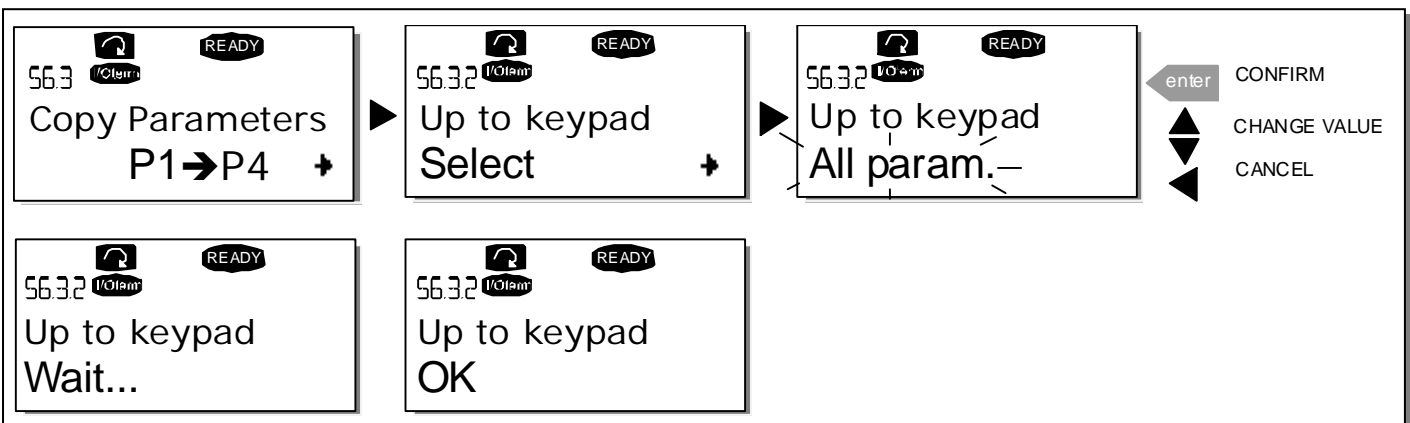

Figure 7-12. Parameter copy to keypad

Download parameters to drive (From keypad, S6.3.3)

This function downloads **one** or **all** parameter groups uploaded to the keypad to a drive provided that the drive is in STOP status.

Enter the *From keypad* page (S6.3.3) from the *Parameter copy menu*. Push the *Menu button right* to enter the edit mode. Use the *Browser buttons* to select either the option *All parameters* or *Application parameters* and press the *Enter button*. Wait until 'OK' appears on the display.

The procedure to download the parameters from keypad to drive is similar to that of from drive to keypad. See above.

Automatic parameter backup (P6.3.4)

On this page you can activate or inactivate the parameter backup function. Enter the edit mode by pressing the *Menu button right*. Choose *Yes* or *No* with the *Browser buttons*.

When the Parameter backup function is activated Vacon NX control keypad makes a copy of the parameters of the presently used application. Every time a parameter is changed the keypad backup is automatically updated.

When applications are changed, you will be asked if you wish the parameters of the **new** application to be uploaded to the keypad. For this to happen, push the *Enter button*. If you wish to keep the copy of the parameters of the **previously used** application saved in the keypad push any other button. Now you will be able to download these parameters to the drive following the instructions given in chapter 7.3.6.3.

If you want the parameters of the new application to be automatically uploaded to the keypad you have to do this for the parameters of the new application once on page 6.3.2 as instructed. **Otherwise the panel will always ask for the permission to upload the parameters.**

Note: Parameters saved in the parameter settings on page **S6.3.1** will be deleted when applications are changed. If you want to transfer the parameters from one application to another you have to upload them first to the keypad.

7.3.6.4 Parameter comparison

In the *Parameter comparison* submenu (**S6.4**), you can compare the **actual parameter values** to the values of your customised parameter sets and those loaded to the control keypad.

The comparison is performed by pushing the *Menu button right* when in the *Compare parameters submenu*. The actual parameter values are first compared to those of the customised parameter Set1. If no differences are detected a '0' is displayed on the lowermost line. But if any of the parameter values differ from those of the Set1 the number of the deviations is displayed together with symbol **P** (e.g. P1→P5 = five deviating values). By pressing the *Menu button right* once again you can still enter the pages where you can see both the actual value and the value it was compared to. In this display, the value on the **Description line** (in the middle) is the default value and the one on the **value line** (lowermost) is the edited value.

Furthermore, you can also edit the actual value with the *Browser buttons* in the *edit mode* that you can reach by pushing the *Menu button right* once again.

In the same way, you can perform the comparison of the actual values to *Set2, Factory Settings* and *Keypad Set*.

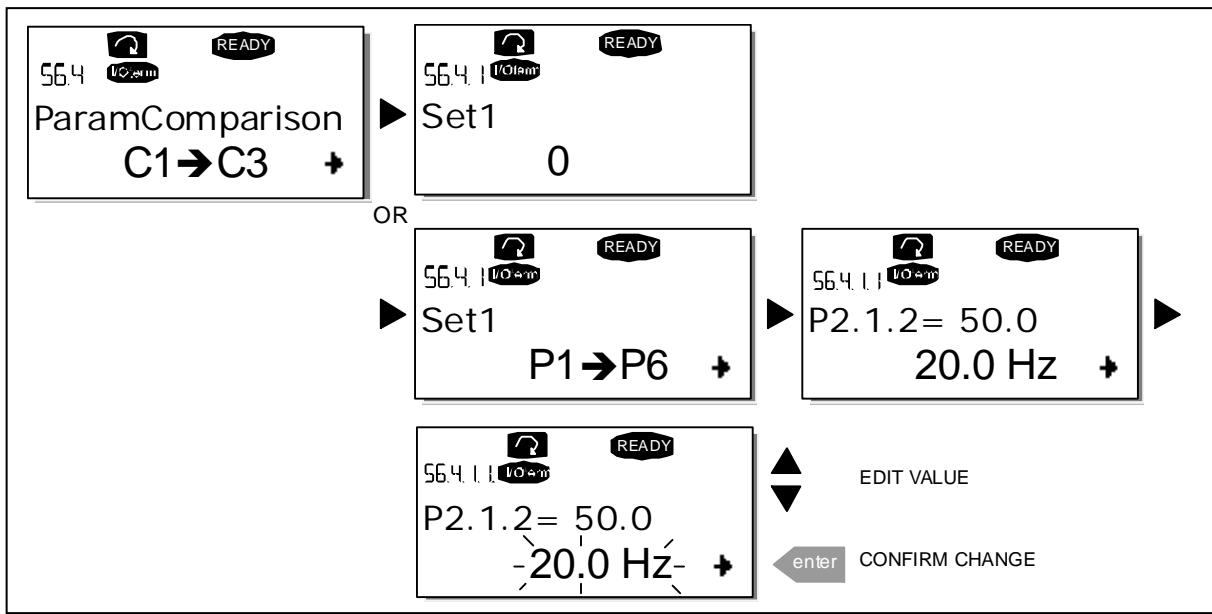

Figure 7-13. Parameter comparison

7.3.6.5 Security

NOTE: The *Security submenu* is protected with a password. Store the password in a safe place!

Password (S6.5.1)

The application selection can be protected against unauthorised changes with the Password function (S6.5.1).

By default, the password function is not in use. If you want to activate the function, enter the edit mode by pushing the *Menu button right*. A blinking zero appears in the display and now you can set a password with the *Browser buttons*. The password can be any number between 1 and 65535.

Note that you can also set the password by digits. In the edit mode, push the *Menu button right* once again and another zero appears on the display. Now set first the units. Then push the *Menu button left* and you can set the tens etc. Finally, confirm the password setting with the *Enter button*. After this, you have to wait until the *Timeout time (P6.6.3)* (see page 100) has expired before the password function is activated. If you now try to change applications or the password itself you will be prompted for the current password. The password will be entered with the *Browser buttons*. Deactivate the password function by entering the value 0.

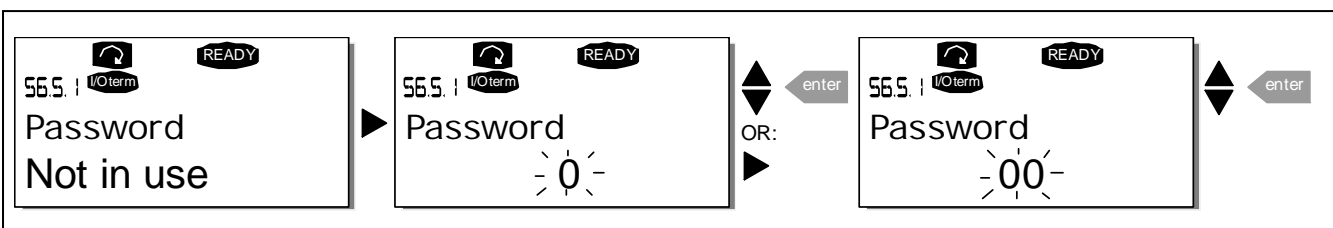

Figure 7-14. Password setting

Note! Store the password in a secure location! No changes can be made unless a valid password is entered!

Parameter lock (P6.5.2)

This function allows the user to prohibit changes to the parameters.

If the parameter lock is activated the text **locked** will appear on the display if you try to edit a parameter value.

NOTE: This function does not prevent unauthorised editing of parameter values.

Enter the edit mode by pushing the *Menu button right*. Use the *Browser buttons* to change the parameter lock status. Accept the change with the *Enter button* or return to the previous level with the *Menu button left*.

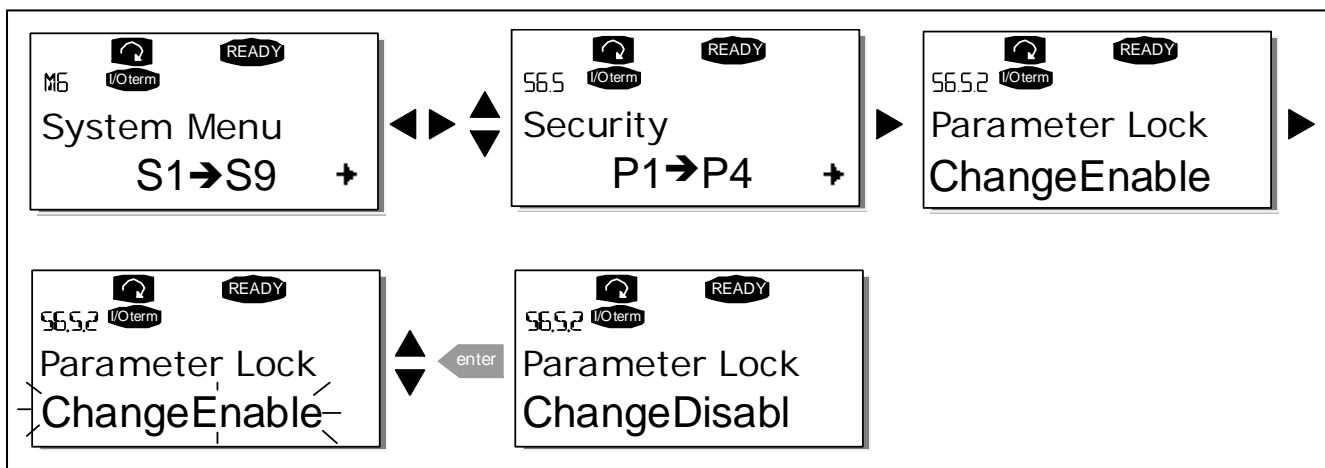

Figure 7-15. Parameter locking

Start-up Wizard (P6.5.3)

The **Start-up Wizard** is a feature on the control keypad to facilitate the commissioning of the frequency converter. If selected active (default), the Start-up Wizard prompts the operator for the **language** and **application** of his/her choice plus for **the values for a set of parameters** common to all applications as well as **for a set of application-dependent** parameters.

Always accept the value with the *Enter button*, scroll options or change values with the *Browser buttons* (up and down arrows).

Set the Start-up Wizard active in the following way: In the System Menu, find page P6.5.3. Press the *Menu button right* once to reach the edit mode. Use the *Browser buttons* to set value *Yes* and confirm the selection with the *Enter button*. If you want to deactivate the function follow the same procedure and give the parameter value *No*.

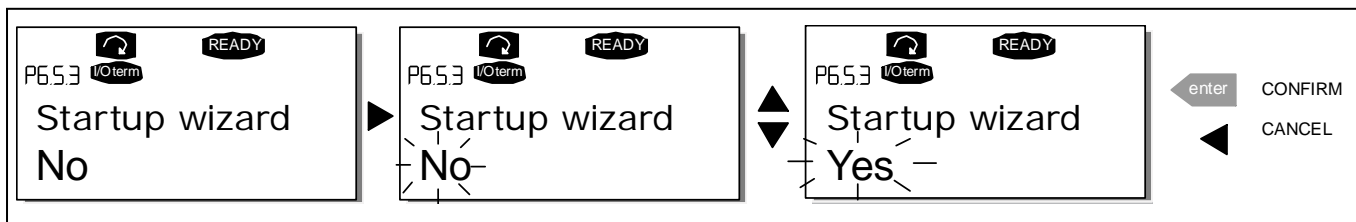

Figure 7-16. Activation of Start-up wizard

Multimonitoring items (P6.5.4)

Vacon alpha-numeric keypad features a display where you can monitor even three actual values at the same time (see chapter 7.3.1 and chapter *Monitoring values* in the manual of the application you are using). On page P6.5.4 of the System Menu you can define if it is possible for the operator to replace the values monitored with other values. See below.

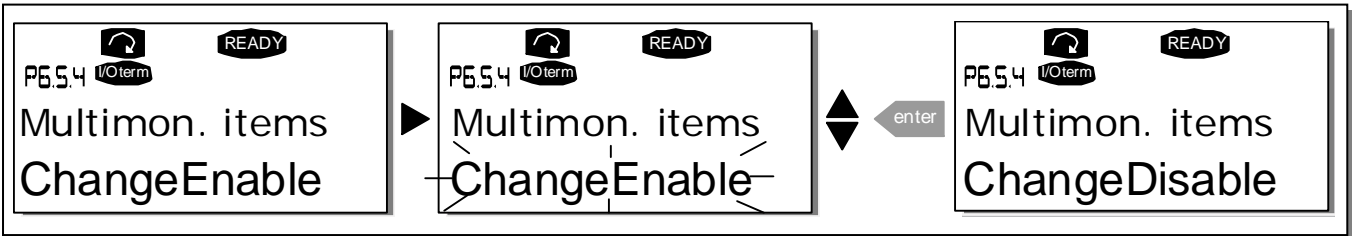

Figure 7-17. Enabling the change of multimonitoring items

7.3.6.6 Keypad settings

In the Keypad settings submenu under the *System menu* you can further customise your frequency converter operator interface.

Locate the Keypad settings submenu (S6.6). Under the submenu, there are four pages (P#) associated with the keypad operation:

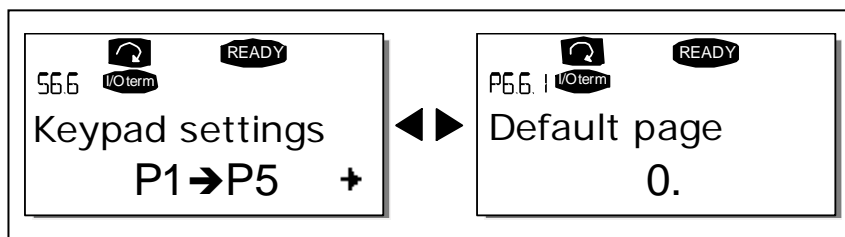

Figure 7-18. Keypad settings submenu

Default page (P6.6.1)

Here you can set the location (page) to which the display automatically moves as the *Timeout time* (see below) has expired or as the power is switched on to the keypad.

If the *Default Page* value is 0 the function is not activated, i.e. the last displayed page remains on the keypad display. Press the *Menu button right* once to enter the edit mode. Change the number of the Main menu with the *Browser buttons*. Pressing the *Menu button right* once again makes you able to edit the number of the submenu/page. If the page you want to move to by default is at the third level repeat the procedure. Confirm the new default page value with the *Enter button*. You can return to the previous step anytime by pushing the *Menu button left*.

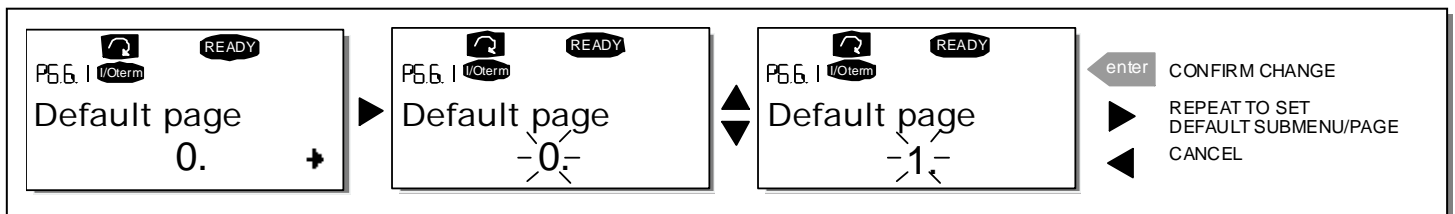

Figure 7-19. Default page function

Default page in the operating menu (P6.6.2)

Here you can set the location (page) in the *Operating menu* (in special applications only) to which the display automatically moves as the set *Timeout time* (see below) has expired or as the power is switched on to the keypad. See setting of Default page above.

Timeout time (P6.6.3)

The Timeout time setting defines the time after which the keypad display returns to the Default page (P6.6.1) see above.

Move to the Edit menu by pressing the *Menu button right*. Set the timeout time you want and confirm the change with the *Enter button*. You can return to the previous step anytime by pushing the *Menu button left*.

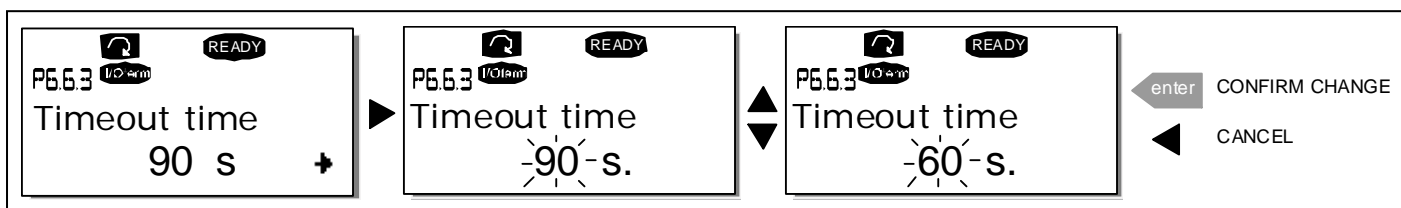

Figure 7-20. Timeout time setting

Note: If the *Default page* value is 0 the *Timeout time* setting has no effect.

Contrast adjustment (P6.6.4)

In case the display is unclear you can adjust its contrast through the same procedure as that for the timeout time setting (see above).

Backlight time (P6.6.5)

Giving a value for the *Backlight time*, you can determine how long the backlight stays on before going out. You can select here any time between 1 and 65535 minutes or '*Forever*'. For the value setting procedure see Timeout time (P6.6.3).

7.3.6.7 Hardware settings

NOTE: The *Hardware settings submenu* is protected with a password (see chapter Password (S6.5.1)). Store the password in a safe place!

In the *Hardware settings submenu (S6.7)* under the *System menu* you can further control some functions of the hardware in your frequency converter. The functions available in this menu are ***Internal brake resistor connection, Fan control, HMI acknowledge timeout and HMI retry.***

Internal brake resistor connection (P6.7.1)

With this function you can tell the frequency converter, whether the internal brake resistor is connected or not. If you have ordered the frequency converter with an internal brake resistor, the default value of this parameter is *Connected*. However, if it is necessary to increase braking capacity by installing an external brake resistor, or if the internal brake resistor is disconnected for another reason, it is advisable to change the value of this function to *Not conn.* in order to avoid unnecessary fault trips.

Enter the edit mode by pushing the *Menu button right*. Use the *Browser buttons* to change the internal brake resistor status. Accept the change with the *Enter button* or return to the previous level with the *Menu button left*.

Note! The brake resistor is available as optional equipment for all classes. It can be installed internally in classes FR4 to FR6.

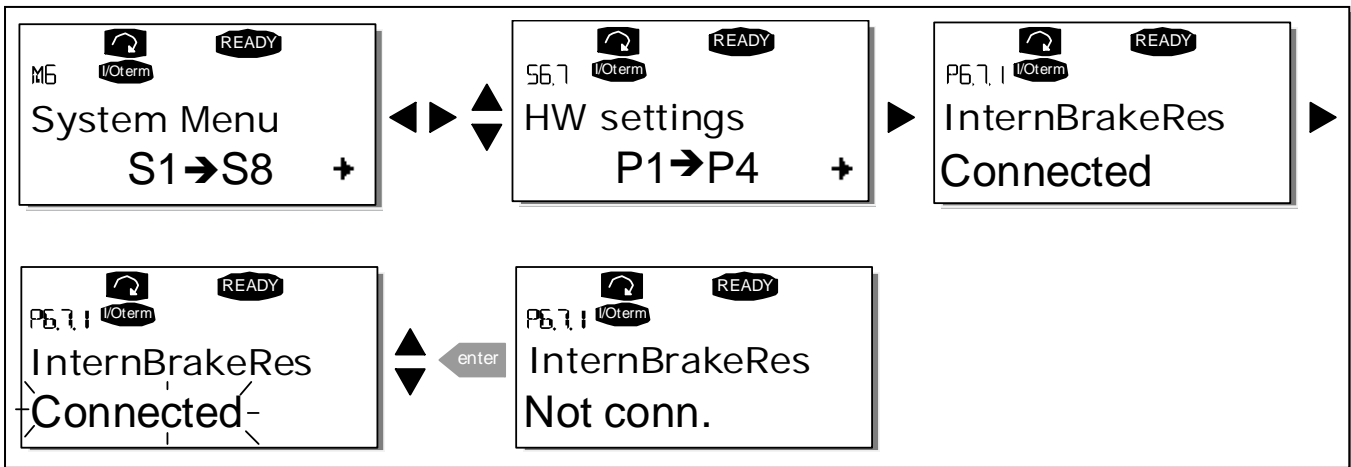

Figure 7-21. Internal brake resistor connection

Fan control (P6.7.2)

This function allows you to control the frequency converter's cooling fan. You can set the fan to run continuously when the power is switched on or depending on the temperature of the unit. If the latter function has been selected the fan is switched on automatically when the heat sink temperature reaches 60°C or the converter is in RUN state. The fan receives a stop command when the heat sink temperature falls to 55°C and the converter is in STOP state. However, the fan runs for about a minute after receiving the stop command or switching on the power, as well as after changing the value from *Continuous* to *Temperature*.

Note! The fan runs always when the drive is in RUN state.

Enter the edit mode by pushing the *Menu button right*. The present mode shown starts to blink. Use the *Browser buttons* to change the fan mode. Accept the change with the *Enter button* or return to the previous level with the *Menu button left*.

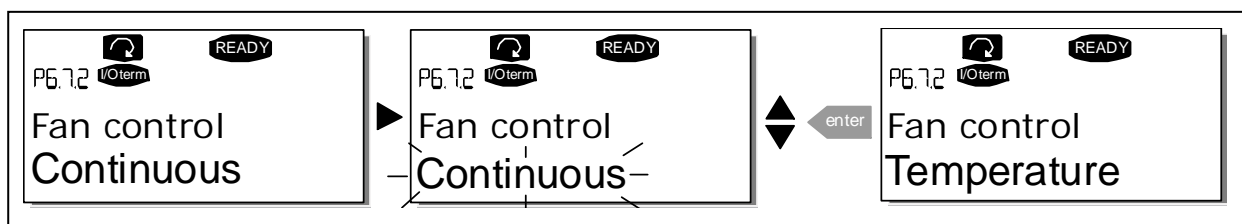

Figure 7-22. Fan control function

HMI acknowledge timeout (P6.7.3)

This function allows the user to change the timeout of the HMI acknowledgement time in cases where there is an additional delay in the RS-232 transmission due to use of modems for communication over longer distances, for example.

Note! If the frequency converter has been connected to the PC with a **normal cable**, the default values of parameters 6.7.3 and 6.7.4 (200 and 5) **must not be changed**.

If the frequency converter has been connected to the PC via a modem and there is delay in transferring messages, the value of par. 6.7.3 must be set according to the delay as follows:

Example:

- Transfer delay between the frequency converter and the PC = 600 ms
- The value of par. 6.7.3 is set to 1200 ms (2 x 600, sending delay + receiving delay)
- The corresponding setting shall be entered in the [Misc]-part of the file NCDrive.ini:
 Retries = 5
 AckTimeOut = 1200
 TimeOut = 6000

It must also be considered that intervals shorter than the AckTimeOut-time cannot be used in NC-Drive monitoring.

Enter the edit mode by pushing the *Menu button right*. Use the *Browser buttons* to change the acknowledgement time. Accept the change with the *Enter button* or return to the previous level with the *Menu button left*.

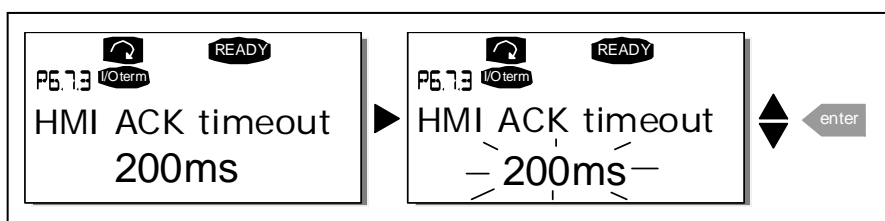

Figure 7-23. HMI acknowledge timeout

Number of retries to receive HMI acknowledgement (P6.7.4)

With this parameter you can set the number of times the drive will try receive acknowledgement if this does not succeed within the acknowledgement time (P6.7.3) or if the received acknowledgement is faulty.

Enter the edit mode by pushing the *Menu button right*. The present value shown starts to blink. Use the *Browser buttons* to change the amount of retries. Accept the change with the *Enter button* or return to the previous level with the *Menu button left*.

See Figure 7-23 for the procedure of changing the value.

7.3.6.8 System info

In the *System info submenu (S6.8)* you can find frequency converter-related hardware and software information as well as operation-related information.

Total counters (S6.8.1)

In the *Total counters page (S6.8.1)* you can find information related to the frequency converter operation times, i.e. the total numbers of MWh, operation days and operation hours passed so far. Unlike the counters in the Trip counters, these counters cannot be reset.

Note! The Power On time counter (days and hours) runs always, when the power is on.

Page	Counter	Example
C6.8.1.1.	MWh counter	
C6.8.1.2.	Power On day counter	Value on display is 1.013. The drive has operated for 1 year and 13 days.
C6.8.1.3.	Power On hour counter	Value on display is 7:05:16. The drive has operated for 7 hours 5 minutes and 16 seconds.

Table 7-7. Counter pages

Trip counters (S6.8.2)

Trip counters (menu S6.8.2) are counters the values of which can be reset i.e. restored to zero. You have the following resettable counters at your disposal. See Table 7-7 for examples.

Note! The trip counters run only when the motor is running.

Page	Counter
T6.8.2.1	MWh counter
T6.8.2.3	Operation day counter
T6.8.2.4	Operation hour counter

Table 7-8. Resettable counters

The counters can be reset on pages 6.8.2.2 (Clear MWh counter) and 6.8.2.5 (Clear Operation time counter).

Example: When you want to reset the operation counters you should do the following:

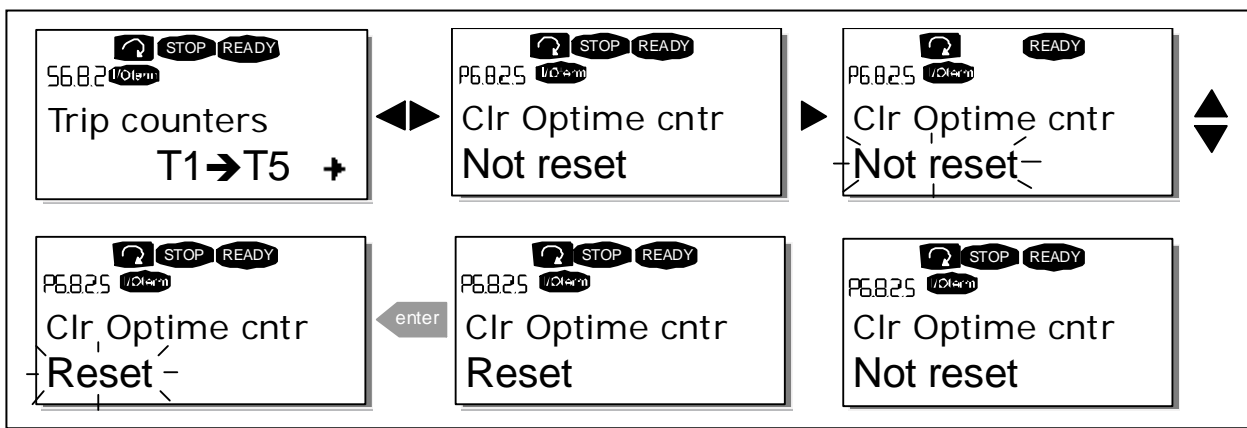

Figure 7-24. Counter reset

Software (S6.8.3)

The Software information page includes information on the following frequency converter software related topics:

Page	Content
6.8.3.1	Software package
6.8.3.2	System software version
6.8.3.3	Firmware interface
6.8.3.4	System load

Table 7-9. Software information pages

Applications (S6.8.4)

At location **S6.8.4** you can find the *Applications submenu* containing information about not only the application currently in use but also all other applications loaded into the frequency converter. The information available is:

Page	Content
6.8.4.#	<i>Name of application</i>
6.8.4.#.1	Application ID
6.8.4.#.2	Version
6.8.4.#.3	Firmware interface

Table 7-10. Applications information pages

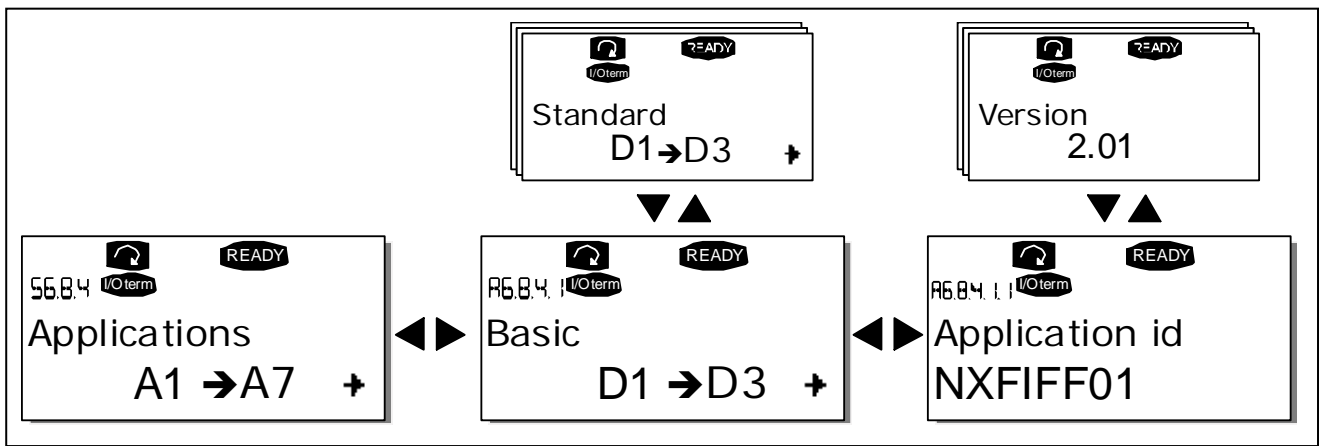

Figure 7-25. Applications info page

In the *Applications* information page, push the *Menu button right* to enter the Application pages of which there are as many as there are applications loaded into the frequency converter. Locate the application you want information about with the *Browser buttons* and then enter the *Information pages* with the *Menu button right*. Use again the *Browser buttons* to see the different pages.

Hardware (S6.8.5)

The *Hardware* information page provides information on the following hardware-related topics:

Page	Content
6.8.5.1	Power unit type code
6.8.5.2	Nominal voltage of the unit
6.8.5.3	Brake chopper
6.8.5.4	Brake resistor

Table 7-11. Hardware information pages

Expander boards (S6.8.6)

In the *Expander boards* pages you find information about the basic and option boards connected to the control board (see Chapter 6.2).

You can check the status of each board slot by entering the *Expander boards* page with the *Menu button right* and using the *Browser buttons* to choose the board whose status you wish to check. Push the *Menu button right* again to display the status of the board. The keypad will also display the program version of the respective board when you push either one of the *Browser buttons*.

If no board is connected to the slot the text '*no board*' will be shown. If a board is connected to a slot but the connection is somehow lost the text '*no conn.*' is displayed. See Chapter 6.2 and Figure 6-23 and Figure 6-24 for more information.

For more information on the expander board-related parameters, see Chapter 7.3.7.

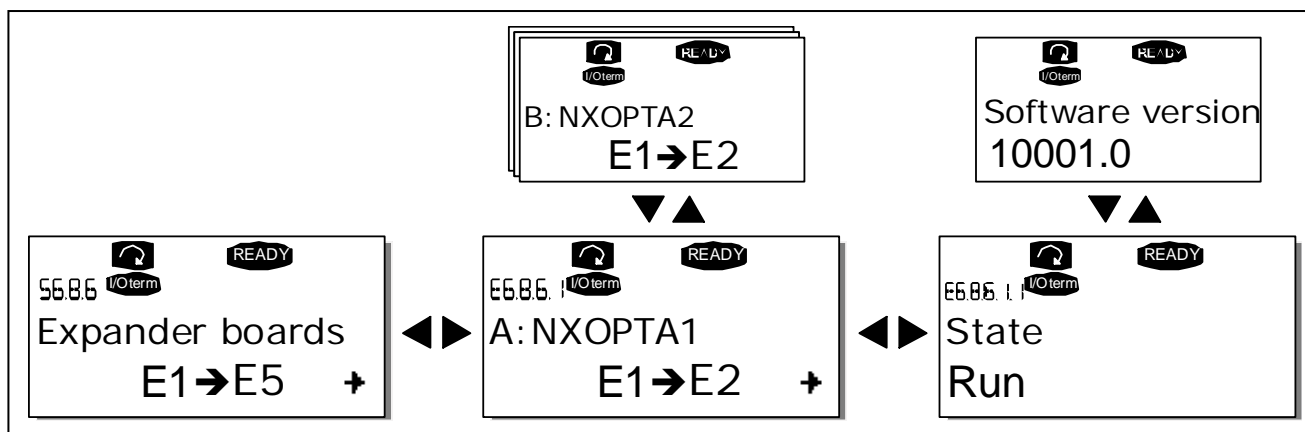

Figure 7-26. Expander board information menus

Debug menu (S6.8.7)

This menu is meant for advanced users and application designers. Contact factory for any assistance needed.

7.3.7 Expander board menu (M7)

The *Expander board menu* makes it possible for the user 1) to see what expander boards are connected to the control board and 2) to reach and edit the parameters associated with the expander board. Enter the following menu level (G#) with the *Menu button right*. At this level, you can browse through slots (see page 66) A to E with the *Browser buttons* to see what expander boards are connected. On the lowermost line of the display you also see the number of parameters associated with the board. You can view and edit the parameter values in the same way as described in chapter 7.3.2. See Table 7-12 and Figure 7-27.

Expander board parameters

Code	Parameter	Min	Max	Default	Cust	Selections
P7.1.1.1	AI1 mode	1	5	3		1=0...20 mA 2=4...20 mA 3=0...10 V 4=2...10 V 5=-10...+10 V
P7.1.1.2	AI2 mode	1	5	1		See P7.1.1.1
P7.1.1.3	AO1 mode	1	4	1		1=0...20 mA 2=4...20 mA 3=0...10 V 4=2...10 V

Table 7-12. Expander board parameters (board OPT-A1)

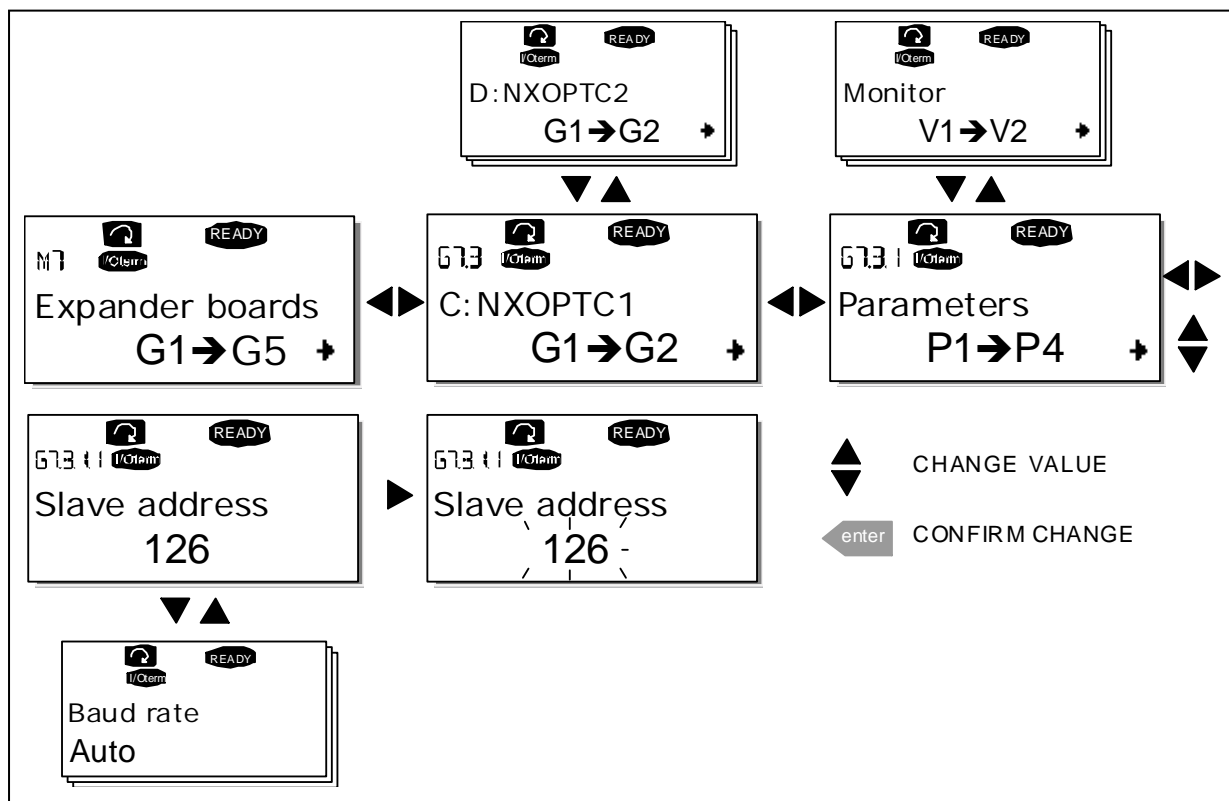

Figure 7-27. Expander board information menu



7.4 Further keypad functions

The Vacon NX control keypad embodies additional application-related functions. See Vacon NX Application Package for more information.

8. COMMISSIONING

8.1 Safety

Before commissioning, note the following directions and warnings:

	1	Internal components and circuit boards of the frequency converter (except for the galvanically isolated I/O terminals) are live when Vacon NX_ is connected to mains potential. Coming into contact with this voltage is extremely dangerous and may cause death or severe injury.
	2	The motor terminals U, V, W and the DC-link/brake resistor terminals -/+ are live when Vacon NX_ is connected to mains, even if the motor is not running.
 WARNING	3	The control I/O-terminals are isolated from the mains potential. However, the relay outputs and other I/O-terminals may have a dangerous control voltage present even when Vacon NX_ is disconnected from mains.
	4	Do not make any connections with the frequency converter connected to the mains.
 HOT SURFACE	5	After having disconnected the frequency converter from the mains, wait until the fan stops and the indicators on the keypad go out (if no keypad is attached see the indicator through the keypad base). Wait 5 more minutes before doing any work on Vacon NX_ connections. Do not even open the cover before this time has expired.
	6	Before connecting the frequency converter to mains make sure that the Vacon NX_ front cover is closed.
	7	When running, the side of converter FR8 is burning hot. Do not touch with hands!
	8	When running, the back of frequency converter FR6 is burning hot. Therefore it MUST NOT be mounted onto a surface which is not fireproof.

8.2 Commissioning of the frequency converter

- 1 Read carefully the safety instructions in Chapter 1 and above and follow them.
- 2 After the installation, pay attention to:
 - that both the frequency converter and the motor are grounded.
 - that the mains and motor cables comply with the requirements given in Chapter 6.1.1.
 - that the control cables are located as far as possible from the power cables (see Chapter 6.1.5, step 3), the shields of the shielded cables are connected to protective earth . The wires may not touch the electrical components of the frequency converter.
 - that the common inputs of digital input groups are connected to +24V or ground of the I/O terminal or the external supply.
- 3 Check the quality and quantity of cooling air (chapter 5.2 and Table 5-11).
- 4 Check the inside of the frequency converter for condensation.
- 5 Check that all Start/Stop switches connected to the I/O terminals are in **Stop**-position.
- 6 Connect the frequency converter to mains.

- 7 Set the parameters of group 1 (See Vacon All in One Application Manual) according to the requirements of your application. At least the following parameters should be set:
- motor nominal voltage
 - motor nominal frequency
 - motor nominal speed
 - motor nominal current

You will find the values needed for the parameters on the motor rating plate.

8 Perform run test **without motor**

Perform either Test A or Test B:

A Controls from the I/O terminals:

- a) Turn the Start/Stop switch to ON position.
- b) Change the frequency reference (potentiometer)
- c) Check in the Monitoring menu **M1** that the value of Output frequency changes according to the change of frequency reference.
- d) Turn the Start/Stop switch to OFF position.

B Control from the control keypad:

- a) Change the control from the I/O terminals to the keypad as advised in Chapter 7.3.3.1.

- b) Push the **Start button** on the keypad .

- c) Move over to the Keypad control menu (**M3**) and Keypad Reference submenu (Chapter 7.3.3.2) and change the frequency reference using the **Browser buttons**



- d) Check in the Monitoring menu **M1** that the value of Output frequency changes according to the change of frequency reference.

- e) Push the **Stop button** on the keypad .

9 Run the start-up tests without the motor being connected to the process, if possible. If this is not possible, secure the safety of each test prior to running it. Inform your co-workers of the tests.

- a) Switch off the supply voltage and wait up until the drive has stopped as advised at Chapter 8.1, step 5.
- b) Connect the motor cable to the motor and to the motor cable terminals of the frequency converter.
- c) See to that all Start/Stop switches are in Stop positions.
- d) Switch the mains ON
- e) Repeat test **8A** or **8B**.

10 Perform the Identification Run. The Identification Run is a part of tuning the motor and the drive specific parameters. It is a tool for commissioning with the aim to find as good parameter values as possible for most drives. The automatic motor identification calculates or measures the motor parameters that are needed for optimum motor and speed control. For closer details on the Identification Run, see All in One Application Manual, par. ID631.

- 11 Connect the motor to the process (if the startup test was run without the motor being connected)
 - a) *Before running the tests, make sure that this can be done safely.*
 - b) *Inform your co-workers of the tests.*
 - c) *Repeat test **8A** or **8B**.*

9. FAULT TRACING

When a fault is detected by the frequency converter control electronics, the drive is stopped and the symbol **F** together with the ordinal number of the fault, the fault code and a short fault description appear on the display. The fault can be reset with the *Reset button* on the control keypad or via the I/O terminal. The faults are stored in the Fault history menu (M5) which can be browsed. The different fault codes you will find in the table below.

The fault codes, their causes and correcting actions are presented in the table below. The shadowed faults are A faults only. The items written in white on black background present faults for which you can program different responses in the application. See parameter group Protections.

Note: When contacting distributor or factory because of a fault condition, always write down all texts and codes on the keypad display.

Fault code	Fault	Possible cause	Correcting measures
1	Overcurrent	Frequency converter has detected too high a current ($>4 \cdot I_H$) in the motor cable: <ul style="list-style-type: none"> – sudden heavy load increase – short circuit in motor cables – unsuitable motor Subcode in T.14 : S1 = Hardware trip S2 = Reserved S3 = Current controller supervision	Check loading. Check motor. Check cables. Make identification run.
2	Overvoltage	The DC-link voltage has exceeded the limits defined. <ul style="list-style-type: none"> – too short a deceleration time – high overvoltage spikes in supply Subcode in T.14 : S1 = Hardware trip S2 = Overvoltage control supervision	Make deceleration time longer. Use brake chopper or brake resistor (available as options) Activate overvoltage controller. Check input voltage.
3	Earth fault	Current measurement has detected that the sum of motor phase current is not zero. <ul style="list-style-type: none"> – insulation failure in cables or motor 	Check motor cables and motor.
5	Charging switch	The charging switch is open, when the START command has been given. <ul style="list-style-type: none"> – faulty operation – component failure 	Reset the fault and restart. Should the fault re-occur, contact the distributor near to you. See Vacon contact info on the Web .
6	Emergency stop	Stop signal has been given from the option board.	Check emergency stop circuit.
7	Saturation trip	Various causes: <ul style="list-style-type: none"> – defective component – brake resistor short-circuit or overload 	Cannot be reset from the keypad. Switch off power. DO NOT RE-CONNECT POWER! Contact factory. If this fault appears simultaneously with Fault 1, check motor cables and motor

Fault code	Fault	Possible cause	Correcting measures
8	System fault	<ul style="list-style-type: none"> - component failure - faulty operation Note exceptional fault data record. S1 = Reserved S2 = Reserved S3 = Reserved S4 = Reserved S5 = Reserved S6 = Reserved S7 = Charging switch S8 = No power to driver card S9 = Power unit communication (TX) S10 = Power unit communication (Trip) S11 = Power unit comm. (Measurement)	Reset the fault and restart. Should the fault re-occur, contact the distributor near to you. See Vacon contact info on the Web .
9	Undervoltage	DC-link voltage is under the voltage limits defined. <ul style="list-style-type: none"> – most probable cause: too low a supply voltage – frequency converter internal fault – defect input fuse – external charge switch not closed Subcode in T.14 : S1 = DC-link too low during run S2 = No data from power unit S3 = Undervoltage control supervision	In case of temporary supply voltage break reset the fault and restart the frequency converter. Check the supply voltage. If it is adequate, an internal failure has occurred. Contact the distributor near to you. See Vacon contact info on the Web .
10	Input line supervision	Input line phase is missing.	Check supply voltage, fuses and cable.
11	Output phase supervision	Current measurement has detected that there is no current in one motor phase.	Check motor cable and motor.
12	Brake chopper supervision	<ul style="list-style-type: none"> – no brake resistor installed – brake resistor is broken – brake chopper failure 	Check brake resistor and cabling. If the these are ok, the chopper is faulty. Contact the distributor near to you. See Vacon contact info on the Web .
13	Frequency converter under-temperature	Heatsink temperature is under -10°C	
14	Frequency converter over-temperature	Heatsink temperature is over 90°C (or 77°C, NX_6, FR6). Overtemperature warning is issued when the heatsink temperature exceeds 85°C (72°C).	Check the correct amount and flow of cooling air. Check the heatsink for dust. Check the ambient temperature. Make sure that the switching frequency is not too high in relation to ambient temperature and motor load.
15	Motor stalled	Motor stall protection has tripped.	Check motor and load.
16	Motor over-temperature	Motor overheating has been detected by frequency converter motor temperature model. Motor is overloaded.	Decrease motor load. If no motor overload exists, check the temperature model parameters.
17	Motor underload	Motor underload protection has tripped.	Check load.
18	Unbalance	Unbalance between power modules in paralleled units. Subcode in T.14 : S1 = Current unbalance S2 = DC voltage unbalance	Should the fault re-occur, contact the distributor near to you.

Fault code	Fault	Possible cause	Correcting measures
22	EEPROM checksum fault	Parameter save fault – faulty operation – component failure	Should the fault re-occur, contact the distributor near to you.
24	Counter fault	Values displayed on counters are incorrect	
25	Microprocessor watchdog fault	– faulty operation – component failure	Reset the fault and restart. Should the fault re-occur, contact the distributor near to you. See Vacon contact info on the Web .
26	Start-up prevented	Start-up of the drive has been prevented. Run request in ON when new application is loaded to the drive	Cancel prevention of start-up if this can be done safely. Remove Run request
29	Thermistor fault	The thermistor input of option board has detected increase of the motor temperature	Check motor cooling and loading Check thermistor connection (If thermistor input of the option board is not in use it has to be short circuited)
30	Safe disable	The input on OPT-AF board has opened	Cancel Safe Disable if this can be done safely.
31	IGBT temperature (hardware)	IGBT Inverter Bridge overtemperature protection has detected too high a short term overload current	Check loading. Check motor size. Make identification run.
32	Fan cooling	Cooling fan of the frequency converter does not start, when ON command is given	Contact the distributor near to you. See Vacon contact info on the Web .
34	CAN bus communication	Sent message not acknowledged.	Ensure that there is another device on the bus with the same configuration.
35	Application	Problem in application software	Contact your distributor. If you are application programmer check the application program.
36	Control unit	NXS Control Unit can not control NXP Power Unit and vice versa	Change control unit
37	Device changed (same type)	Option board or control unit changed. Same type of board or same power rating of drive.	Reset. Device is ready for use. Old parameter settings will be used.
38	Device added (same type)	Option board or drive added.	Reset. Device is ready for use. Old board settings will be used.
39	Device removed	Option board removed.	Reset. Device no longer available.
40	Device unknown	Unknown option board or drive. Subcode in T.14 : S1 = Unknown device S2 = Power1 not same type as Power2	Contact the distributor near to you. See Vacon contact info on the Web .
41	IGBT temperature	IGBT Inverter Bridge overtemperature protection has detected too high a short term overload current	Check loading. Check motor size. Make identification run.
42	Brake resistor overtemperature	Brake resistor overtemperature protection has detected too heavy braking	Set the deceleration time longer. Use external brake resistor.
43	Encoder fault	Problem detected in encoder signals. Subcode in T.14 : 1 = Encoder 1 channel A is missing 2 = Encoder 1 channel B is missing 3 = Both encoder 1 channels are missing 4 = Encoder reversed 5 = Encoder board missing	Check encoder channel connections. Check the encoder board. Check encoder frequency in open loop.

Fault code	Fault	Possible cause	Correcting measures
44	Device changed (different type)	Option board or power unit changed. New device of different type or different power rating.	Reset Set the option board parameters again if option board was changed. Set converter parameters again if power unit was changed.
45	Device added (different type)	Option board of different type added.	Reset Set the option board parameters again.
49	Division by zero in application	Division by zero has occurred in application program.	Contact your distributor if the fault re-occurs while the converter is in run state. If you are application programmer check the application program.
50	Analogue input $I_{in} < 4\text{mA}$ (sel. signal range 4 to 20 mA)	Current at the analogue input is $< 4\text{mA}$. – control cable is broken or loose – signal source has failed	Check the current loop circuitry.
51	External fault	Digital input fault.	Remove fault situation on external device.
52	Keypad communication fault	The connection between the control keypad (or NCDrive) and the frequency converter is broken.	Check keypad connection and possible keypad cable.
53	Fieldbus fault	The data connection between the fieldbus Master and the fieldbus board is broken	Check installation. If installation is correct contact the nearest Vacon distributor. See Vacon contact info on the Web .
54	Slot fault	Defective option board or slot	Check board and slot. Contact the nearest Vacon distributor. See Vacon contact info on the Web .
56	PT100 board temp. fault	Temperature limit values set for the PT100 board parameters have been exceeded	Find the cause of temperature rise
57	Identification	Identification run has failed.	Run command was removed before completion of identification run. Motor is not connected to frequency converter. There is load on motor shaft.
58	Brake	Actual status of the brake is different from the control signal.	Check mechanical brake state and connections.
59	Follower communication	SystemBus or CAN communication is broken between Master and Follower	Check option board parameters. Check optical fibre cable or CAN cable.
60	Cooling	Coolant circulation on liquid-cooled drive has failed.	Check reason for the failure on external system.
61	Speed error	Motor speed is unequal to reference	Check encoder connection. PMS motor has exceeded the pull out torque.
62	Run disable	Run enable signal is low	Check reason for Run enable signal.
63	Emergency stop	Command for emergency stop received from digital input or fieldbus	New run command is accepted after reset.
64	Input switch open	Drive input switch is open	Check the main power switch of the drive.

Table 9-1. Fault codes

HEAD OFFICE AND PRODUCTION:**Vaasa**

Vacon Plc
Runsorintie 7
65380 Vaasa
firstname.lastname@vacon.com
telephone: +358 (0)201 2121
fax: +358 (0)201 212 205

PRODUCTION:**Suzhou, China**

Vacon Suzhou Drives Co. Ltd.
Building 13CD
428 Xinglong Street
Suchun Industrial Square
Suzhou 215126
telephone: +86 512 6283 6630
fax: +86 512 6283 6618

Vacon Traction Oy

Vehnämyllynkatu 18
33580 Tampere
telephone: +358 (0)201 2121
fax: +358 (0)201 212 710

SALES COMPANIES AND REPRESENTATIVE OFFICES:**FINLAND****Helsinki**

Vacon Plc
Äyritie 12
01510 Vantaa
telephone: +358 (0)201 212 600
fax: +358 (0)201 212 699

Tampere

Vacon Plc
Vehnämyllynkatu 18
33580 Tampere
telephone: +358 (0)201 2121
fax: +358 (0)201 212 750

AUSTRALIA

Vacon Pacific
17, Corporate Ave.
Rowville, Victoria 3178
telephone: +61 (03) 92139300
fax: +61 (03) 92139310

AUSTRIA

Vacon AT Antriebssysteme GmbH
Aumühlweg 21
2544 Leobersdorf
telephone: +43 2256 651 66
fax: +43 2256 651 66 66

BELGIUM

Vacon Benelux NV/SA
Interleuvenlaan 62
3001 Heverlee (Leuven)
telephone: +32 (0)16 394 825
fax: +32 (0)16 394 827

CHINA

Vacon Suzhou Drives Co. Ltd.
Beijing Office
A205, Grand Pacific Garden Mansion
8A Guanhua Road
Beijing 100026
telephone: +86 10 6581 3734
fax: +86 10 6581 3754

FRANCE

Vacon France
ZAC du Fresne
1 Rue Jacquard – BP72
91280 Saint Pierre du Perray CDIS
telephone: +33 (0)1 69 89 60 30
fax: +33 (0)1 69 89 60 40

GERMANY

Vacon GmbH
Gladbecker Strasse 425
45329 Essen
telephone: +49 (0)201 806 700
fax: +49 (0)201 806 7099

INDIA

Vacon India
Flat no T1, 3rd floor
VNS Ashok Apartment
Plot no. 9A, New Beach Road
Thiruvannamiyur
Chennai-600041
Tel. +91 44 245 150 18

ITALY

Vacon S.p.A.
Via F.lli Guerra, 35
42100 Reggio Emilia
telephone: +39 0522 276811
fax: +39 0522 276890

THE NETHERLANDS

Vacon Benelux BV
Weide 40
4206 CJ Gorinchem
telephone: +31 (0)183 642 970
fax: +31 (0)183 642 971

NORWAY

Vacon AS
Langgata 2
3080 Holmestrand
telephone: +47 330 96120
fax: +47 330 96130

RUSSIA

ZAO Vacon Drives
Bolshaja Jakimanka 31,
109180 Moscow
telephone: +7 (095) 974 14 47
fax: +7 (095) 974 15 54
ZAO Vacon Drives
2ya Sovetskaya 7, office 210A
191036 St. Petersburg
telephone: +7 (812) 332 1114
fax: +7 (812) 279 9053

SPAIN

Vacon Drives Ibérica S.A.
Miquel Servet, 2. P.I. Bufalvent
08243 Manresa
telephone: +34 93 877 45 06
fax: +34 93 877 00 09

SWEDEN

Vacon AB
Torget 1
172 67 Sundbyberg
telephone: +46 (0)8 293 055
fax: +46 (0)8 290 755

THAILAND

Vacon South East Asia
335/32 5th-6th floor
Srinakarin Road, Prawet
Bangkok 10250
Tel. +66 (0)85 100 7090

UNITED ARAB EMIRATES

Vacon Middle East and Africa
Block A, Office 4A 226
P.O.Box 54763
Dubai Airport Free Zone
Dubai
Tel. +971 (0)4 204 5200
Fax: +971 (0)4 204 5203

UNITED KINGDOM

Vacon Drives (UK) Ltd.
18, Maizefield
Hinckley Fields Industrial Estate
Hinckley
LE10 1YF Leicestershire
telephone: +44 (0)1455 611 515
fax: +44 (0)1455 611 517

Vacon distributor: